



SOHORAID
ST2 Series
User Manual

» ST2 Series User Manual	1
1. Environmental Requirements	1
2. Product Appearance and Packaging Content	1
3. Hardware Requirements and Precautions	2
4. Hardware Installation.....	3
5. RAID Mode Setting.....	4
6. Description of HDD Indicators	5
7. Hard Drive Replacement and Data Rebuild Instructions...	5
8. Install The Operation System Into This Device	6
» ST2 Series 產品使用說明	11
1. 環境需求	11
2. 產品外觀及包裝內容	11
3. 硬體需求與注意事項	12
4. 硬體安裝	13
5. RAID 模式切換設定	14
6. 燈號說明	15
7. 更換硬碟與資料重建說明.....	15
8. 外接磁碟安裝作業系統.....	16

About this Manual

Thank you for choosing the STARDOM product. This manual will familiarize you with the STARDOM ST2 product. We recommend reading through this manual before using the STARDOM ST2 product. The information provided in this manual was checked before publication, but the actual product specifications may have changed before shipping; Latest product specifications and updates can be found at www.STARDOM.com.tw. No separate notifications will be provided by our company. If you would like to receive the latest STARDOM product information, manuals, and firmware, or have any questions regarding STARDOM products, please contact your local supplier or visit www.STARDOM.com.tw for more information.

All product-related content in this manual are copyrighted by RAIDON TECHNOLOGY, INC.

1. Environmental Requirements

Operating temperature: 5 ~ 35 °C (41 ~ 95 °F)

Storage temperature : -20 ~ 47°C (-4 ~ 116 °F)

Operating voltage: 100 ~ 240V AC

2. Product Appearance and Packaging Content

The following items should be inside the package upon opening:

ST2-BA31 product x1 (with removable drive tray enclosed x2)	ST2-B31 product x1 (with removable drive tray enclosed x2)	ST2-B31A product x1 (with removable drive tray enclosed x2)
USB 3.2 C to C cable x1	USB 3.2 C to C cable x1	— —
USB 3.2 C to A cable x1	— —	USB 3.2 C to A cable x1
Power cable x1	Power cable x1	Power cable x1
AC/DC Adapter x1	AC/DC Adapter x1	AC/DC Adapter x1
Quick setup guide x1	Quick setup guide x1	Quick setup guide x1
Screws and Ejector pin	Screws and Ejector pin	Screws and Ejector pin

V1.3

- Please check the product and accessories for any defect or missing parts. If you have any questions, please contact your product supplier.
- Please visit the official website - Download page (<http://www.stardom.com.tw/STARDOM2016/download.php>) to download drivers and other related resources.

Front and rear view

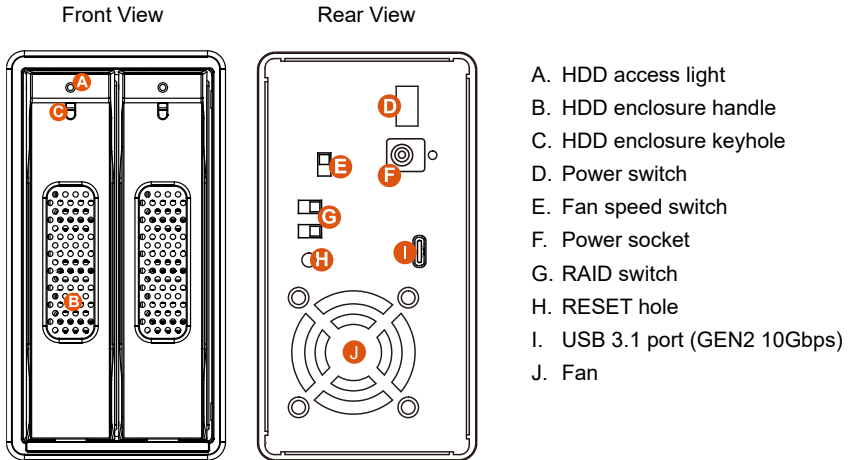

NOTE:

Please make sure that the product is connected to the host (power on status) before turning on the power, otherwise the product will be on the sleep mode.

3. Hardware Requirements and Precautions

1. This system can only transfer data to one computer through one interface at a time.
2. After the hard disk is formatted, the actual total capacity of the ST2 detected by the computer operating system will vary from the sum of all hard disk capacities stated by the manufacturer.
3. All existing data will be deleted when this product is set up for the first time. Please ensure that all data on the hard disk has been backed up before installation to avoid data loss.
4. Before a new HDD is installed in the ST2, please make sure that there are no bad tracks or defects to avoid data loss.
5. If the ST2 needs to be shut down or disconnected, please ensure the HDD is safely removed through your operating system before turning off the power.
6. To prevent data loss, do not remove any of the hard disks while the system is running.
7. Once the system has been initialized, do not switch hard disks around during use. Doing so may prevent the RAID from being recognized by the system.
8. Once RAID mode has been set up, the switching of hard drives will lead to the removal of data from the hard disks. Please be sure to backup the data on the hard disk before making any switches.
9. Please always connect the USB cable to the computer to ensure the energy saving function operating normally.
10. If the ST2 needs to be shut down or disconnected, please ensure the HDD is safely removed through your operating system before turning off the power.

11. Once the computer turns to "Standby" or "Sleep" mode, ST2 will still complete the rebuilding function. However, it will not change to "Standby" mode after rebuilding. You need to shut down the ST2 manually or wake up the computer to synchronize "Standby" or "Sleep" mode together.
12. ST2 uses a 12V/5V AC/DC Adapter. Please do not use other non-certified Power Adapter to avoid damaging to your ST2 unit.
13. We strongly recommend backing up important data stored on the ST2 to another storage device or a remote site. STARDOM will not be held liable for the damage or loss of data you stored on the ST2.

4. Hardware Installation

Please follow the steps below to complete the hardware installation process:

- Step 1 Use the provided key in the Accessories Kit and insert it into the Key Access Opening to eject the Removable Drive Latch and extract the Removable Drive Tray.
- Step 2 For 3.5" HDD/SSD, please secure it by using six of the larger screws included in the accessory kit. For 2.5" HDD/SSD, please secure it by using four of the smaller screws included in the accessory kit. After installing two HDDs into Trays, please insert them into ST2, and then latch the handle.

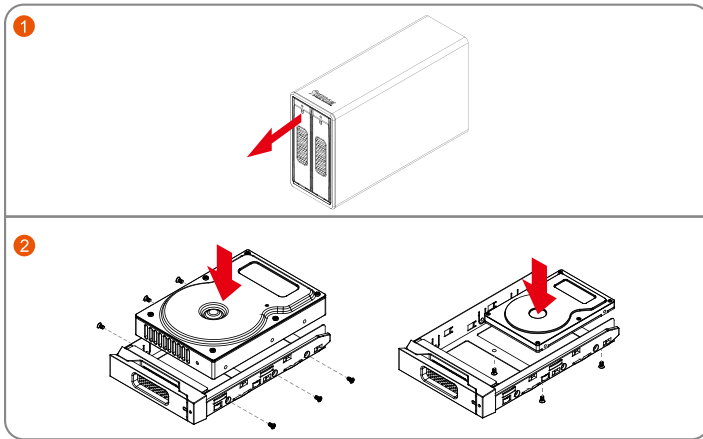

Note: Please avoid using hard disk drives from different manufacturers or different models from the same manufacturer as this may impact system performance.

- Step 3 After installing two HDDs into Trays, please insert them into ST2, and then latch the handle.
- Step 4 Please set RAID mode at the back-plate of ST2 unit for RAID 1, RAID 0, JBOD, and BIG.
- Step 5 Depending on the type of computer USB port, select the corresponding USB cable from the accessory to connect the computer to the USB port of the ST2; finally, connect the power cable to the power adapter, and connect the two ends of the cable to the ST2 and the power outlet respectively.
- Step 6 After completing hardware installation, turn on the power and follow the instruction of Disk Utility to format the two HDDs, you then could start using your new ST2.

V1.3

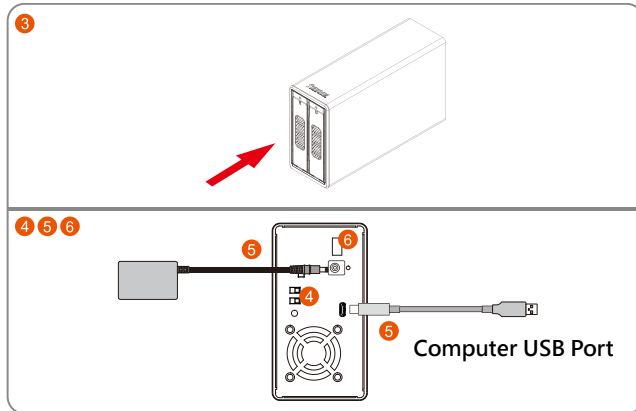

※ If you are using a USB 3.2 C to A cable, the Type-A on the host side needs to be USB 3.2 Gen2 for best access performance.

V1.3

5. RAID Mode Setting



RAID 0 : Provide a big storage capacity and the data transfer efficiency, but no data protection feature.

RAID 1 : Because of this Mirroring feature, your two HDDs/SSDs will keep an identical data after your writing works. In case one of the two HDDs/SSDs is defect, ST2 would still work fine with only one of them. And once inserting a good HDD/SSD as the defect replacement, it will do the rebuilding work by itself.

BIG : You could enjoy a double memory capacity from this BIG feature, but no data protection feature.

JBOD : With JBOD mode, you could actually use the two HDDs/SSDs as the normal two storages for your large memory capacity requirement, but no data protection feature.

The Standard Procedure to Switch RAID Setting

Step-1: Please first connect ST2 to your Mac with Thunderbolt cable..

Step-2: Please set RAID Dip Switch to the position you choose.

Step-3: Please use the Key to press the hidden RESET key at the back-plate, hold and wait for the end of Blue-Purple LED blinking till a stable Blue light.

Step-4: Please turn off your ST2, and re-turn it on again. You now have reset ST2 with a new RAID mode successfully.

6. Description of HDD Indicators

Status	HDD Status Light		
	RAID 0, BIG	RAID 1	JBOD
HDD idle	Blue light always on	Blue light always on	Blue light always on
No HDD detected	Red light always on	Red light always on	Red light always on
HDD failed	Red light flashing	Red light flashing	N/A
RAID failed	Red light flashing	Red light flashing	N/A
Data access	Blue light flashing	Blue light flashing	Blue light flashing
Rebuilding data - Source HDD	N/A	Breathing Blue Light	N/A
Rebuilding data - Target HDD	N/A	Breathing Purple Light	N/A

7. Hard Drive Replacement and Data Rebuild Instructions

1. During the use of ST2, if you are required to replace a malfunctioning drive, refer to chapter 4“Hardware Installation”. Once drive replacement is completed and it is turned on, ST2 will perform data rebuilding procedure automatically.
2. If, during the rebuilding process, a drive malfunctions and is unable to continue the rebuilding process, please restart ST2 to check and see that whether the drive is in fact malfunctioning. If it is, please refer to chapter 4 “Hardware Installation” to replace the malfunctioning drive.

Note:

ST2 allows suspension during data rebuilding process. If you turn off the power during the process, the system will automatically continue to process the remains the next time you turn on the power of the unit. Please do not change the position and sequence of the drives at any time.

8. Install The Operation System Into This Device

Install macOS (Use macOS Mojave 10.14 for example)

1. Need to have network online capabilities. If a wireless network is available, you can choose it from the Wi-Fi menu in the menu bar. This menu is also available in macOS Recovery.
2. Turn on your Mac and immediately press and hold Command (⌘)-R. Continue holding until you see the Apple logo or a spinning globe. Startup is complete when you see the utilities window:

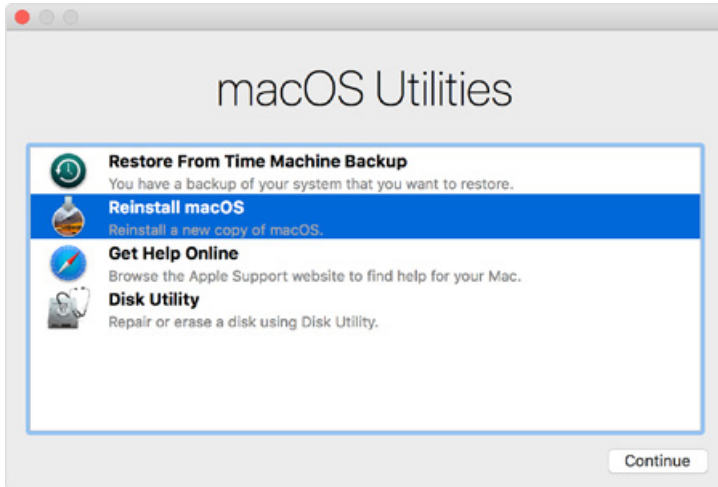

3. If you need to erase your disk before installing macOS, select Disk Utility from the Utilities window, then click Continue. You probably don't need to erase, unless you're selling or giving away your Mac or have an issue that requires you to erase.

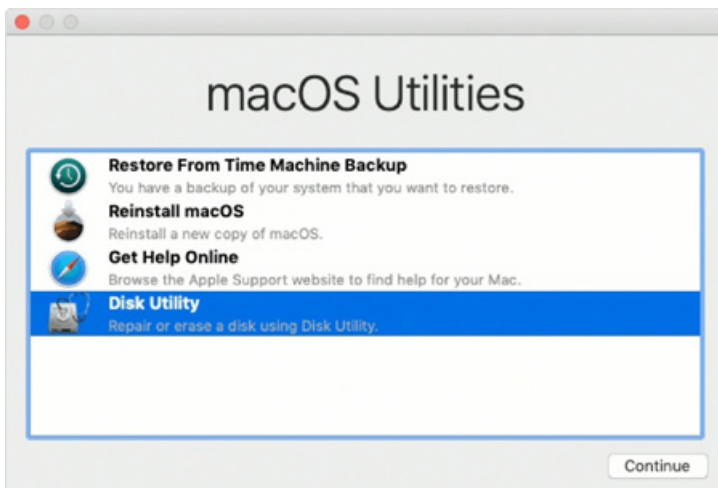

4. Install macOS. Choose Reinstall macOS from the Utilities window, and click continue.

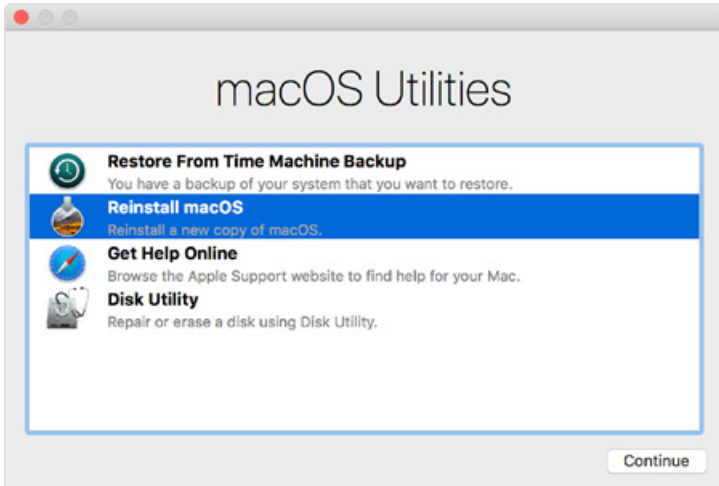

5. Follow the onscreen instructions, select agree to the software license agreement, and then select the disk to start the installation.



6. Please allow installation to complete without putting your Mac to sleep or closing its lid. During installation, your Mac might restart and show a progress bar several times, and the screen might be empty for minutes at a time.

Install Windows (Use Windows 10 Home Edition for example)

1. The following content is an example of using the software "WinToUSB Free Edition". For related specifications and copyrights, please refer to [the software official website](#) for details.
2. After the software is installed, press the shortcut icon of the desktop twice to open Hasleo WinToUSB.



3. On the left side of the interface, select "Mirror to USB" and click the right folder icon to select the ISO file for Windows 10.



4. Select the version of Windows you want to install and go to the next step.

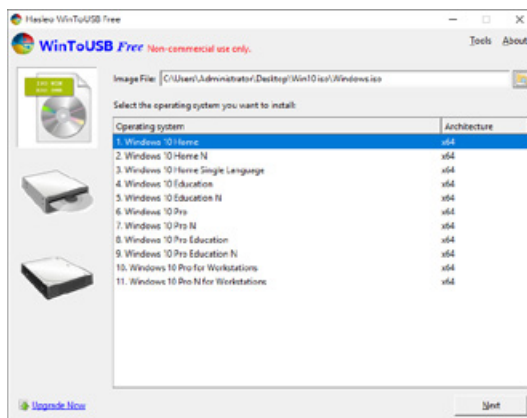

Note: WinToUSB Free Edition does not support Windows Professional and Enterprise editions.

5. Select the USB external drive to install.

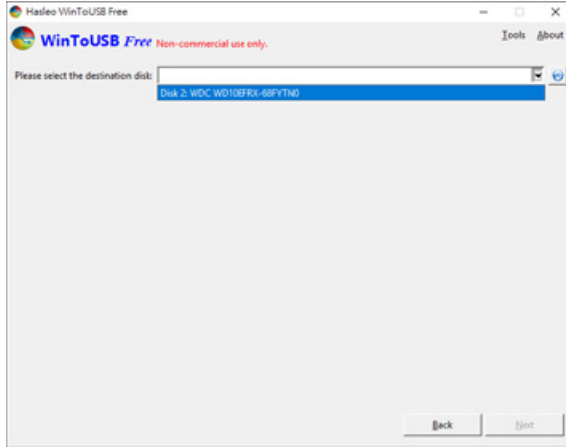

6. Select the version of the disk partition configuration according to your personal hardware specifications, then execute "Yes" to proceed to the next step.



7. Follow the default and follow the next step.

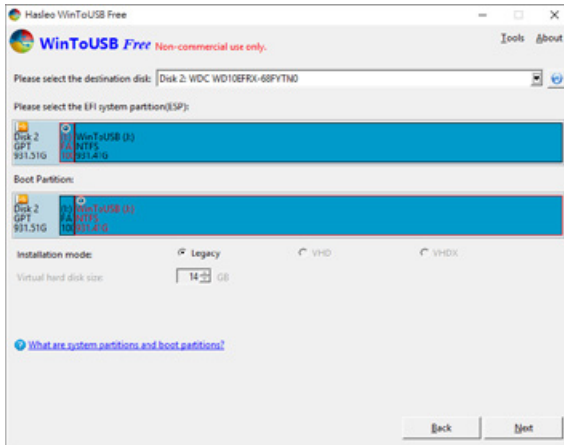

8. Windows 10 is installed to an external hard drive. After the installation is complete, click the "End" button, and then confirm to leave.

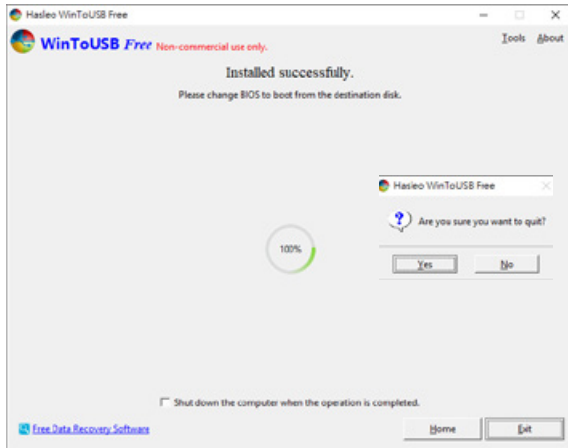

9. Confirm that the external hard disk is inserted in the USB slot of the computer. After rebooting, enter the BIOS or UEFI adjusts to the USB external hard disk box as the first boot sequence, and saves the settings and leaves.

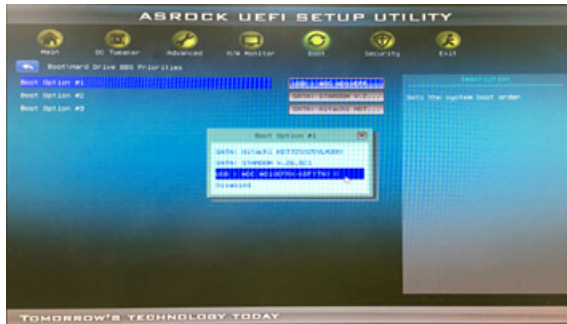

Note: The screenshot is for illustration only, and the actual situation varies depending on each motherboard.

10. Then start the installation process for Windows 10, and follow the system instructions and personal requirements to complete the setup.

關於這份手冊

感謝您使用 STARDOM 的產品。本手冊將介紹 STARDOM ST2 產品。在您開始使用 STARDOM ST2 產品前，建議您先閱讀過本手冊。手冊裡的資訊在出版前雖已被詳細確認，實際產品規格仍將以出貨時為準；任何產品規格或相關資訊更新請您直接到 www.stardom.com.tw 網站查詢，本公司將不另行通知。若您想獲得 STARDOM 最新產品訊息、使用手冊、韌體，或對 STARDOM 產品有任何疑問，請您聯絡當地供應商或到 www.stardom.com.tw 取得相關訊息。

本手冊相關產品內容歸銳銳科技股份有限公司版權所有

1. 環境需求

工作溫度：5 ~ 35 °C (41 ~ 95 °F)

儲存溫度：-20 ~ 47°C (-4 ~ 116 °F)

工作電壓：100 ~ 240V AC

2. 產品外觀及包裝內容

打開包裝外盒後，包裝內容應包含下列組件：

ST2-BA31 產品 x1 (內含抽取盒 x2)	ST2-B31 產品 x1 (內含抽取盒 x2)	ST2-B31A 產品 x1 (內含抽取盒 x2)
USB 3.2 C to C 連接線 x1	USB 3.2 C to C 連接線 x1	— —
USB3.1 C to A 連接線 x1	— —	USB3.1 C to A 連接線 x1
電源線 x1	電源線 x1	電源線 x1
電源轉換器 x1	電源轉換器 x1	電源轉換器 x1
快速安裝導引 x1	快速安裝導引 x1	快速安裝導引 x1
螺絲及頂針	螺絲及頂針	螺絲及頂針

V1.3

- 請先確認相關配件與產品本身是否有受損或是缺少配件，若有任何疑問，請與您的經銷商或業務人員聯絡。
- 請前往官網 - 產品資料下載頁面 (<http://www.stardom.com.tw/STARDOM2016/download.php>) 下載其餘相關資源。

正面與背面示意圖

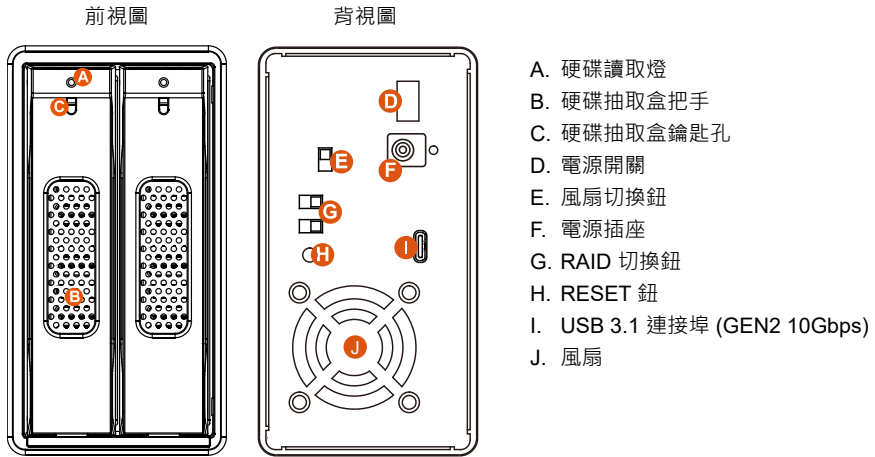

注意：開啟產品電源前，請確認產品與主機端（開機狀態）已連接，否則產品將進入休眠狀態。

3. 硬體需求與注意事項

1. 本系統同一時間只可透過一組介面與一台電腦執行資料傳輸。
2. 硬碟格式化後，由電腦主機作業系統所辨識 ST2 的實際總容量會與硬碟廠所標示的容量加總後，將有所差異。
3. 第一次使用本產品進行設定時，資料會被全數清除。請於硬碟置入前，確認硬碟已備份，避免資料遺失。
4. 在安裝新硬碟到 ST2 之前，請先確認硬碟是沒有壞軌而且是沒有故障的，以避免資料受損。
5. 當您需要關閉或移除 ST2 時，務必透過您所操作的作業系統中執行硬碟安全移除後，方可進行電源關閉的動作。
6. 當系統運作時，請勿任意移除任何一顆硬碟，以免導致資料遺失。
7. 完成系統初始化安裝後，在使用上請勿任意變更硬碟位置；此動作將可能導致系統無法形成 RAID。
8. RAID 模式一旦設定完成，若要進行切換，因切換過程中將會清除硬碟中的資料，請務必先將硬碟中的資料另行備份後再行切換。
9. 為了確保節能功能的正常運作，請將 USB 連接線常態性與電腦端保持連接。
10. 當您需要關閉或移除 ST2 時，務必透過您所操作的作業系統中執行硬碟安全移除後，方進行電源關閉的動作。
11. 在資料自動重建狀態下，若電腦端進入系統待命或是休眠狀態，ST2 會持續完成重建；但當重建完成後將不會進入待命狀態。此時需用手動方式關機，或是先將電腦系統回復到正常運作狀態後，之後才能再與電腦端同步進入待命或是休眠狀態。

12. ST2 使用 12V 規格電源轉接器，請勿使用 5V 電源轉接器以免損壞機器及資料。
13. 強烈建議除了使用 ST2 的資料儲存功能外，請針對重要資料備份到另一個儲存裝置上或遠端備份，
雙重備份您重要的資料。若您儲存在 ST2 的資料損毀或遺失，STARDOM 將不負任何的責任。

4. 硬體安裝

請參照以下步驟完成硬體安裝

1. 請使用零件包中所附的頂針插入硬碟抽取盒頂針孔，開啟硬碟抽取盒把手便將抽取盒取出。
2. 將硬碟安裝到抽取盒上，並以配件包內附的螺絲加以固定，以避免不必要的移動對硬碟造成傷害。

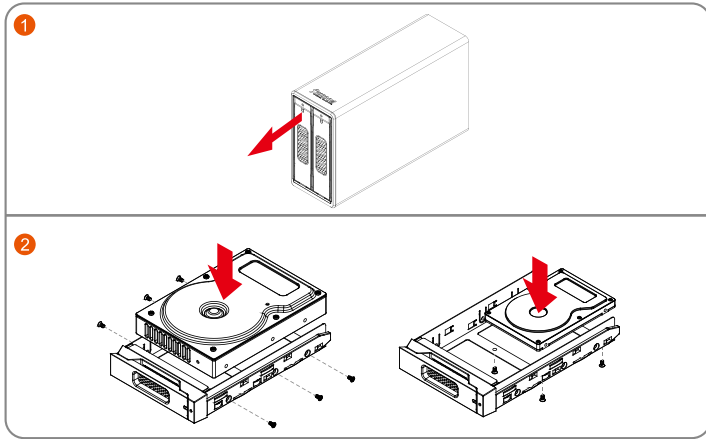

注意：不建議使用不同廠牌，或是同廠牌不同型號的硬碟，避免影響效能。

3. 硬碟安裝完成後，請將抽取盒平移放入主機內，並關上把手。
4. 透過機體背面的 RAID 切換鈕，設定所要使用的 RAID 模式。
5. 視電腦 USB 埠類型選擇配件中的對應的 USB 連接線，連接電腦與 ST2 的 USB 埠；最後將電源線與電源轉接器連接好，並將兩端接頭各自接到 ST2 及電源插座。
6. 硬體安裝完成。開啟電源後請透過作業系統進行後續格式化設定。請依照電腦作業系統指示進行硬碟格式化，完成硬碟格式化後，便可以進行資料的讀寫。

※ 若您使用的是 USB 3.2 C to A 連接線，主機端的 Type-A 需為 USB 3.2 Gen2 規格方可達到最佳存取效能。

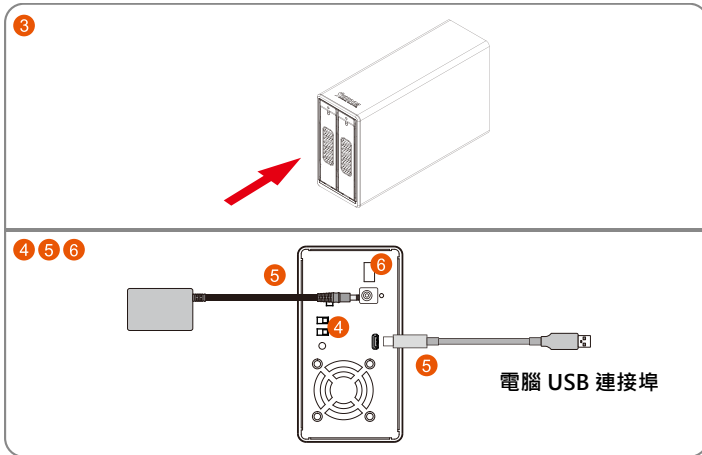

5. RAID 模式切換設定



RAID 0：一個大的獨立資料儲存容量，並可加速資料存取但無資料保護功能。

RAID 1：兩顆硬碟是鏡射關係因此擁有相同的資料，因此有一顆硬碟損毀仍然可以正常運作。當放入新硬碟取代損毀硬碟後，系統會自動將資料重建到新的硬碟。

BIG：兩顆硬碟的容量會被加總成一個大儲存容量，但無資料保護功能。

JBOD：可對兩顆獨立硬碟進行管理的工作，能大幅增加硬碟管理上的便利性，但無資料保護功能。

切換 RAID 設定的標準程序：

步驟 1：請在 ST2 連線到電腦後，一併打開電腦和 ST2 的電源開關。

步驟 2：請在藍燈恆亮時，將在 ST2 背板上設定 RAID 設定的「切換開關」調到你所要的設定位置。

步驟 3：請使用頂針插入「重置鍵」，待前面板抽取盒上的閃爍藍紫燈結束、並轉成恆亮藍燈後鬆開頂針。

步驟 4：請您再做一次關、開 ST2 電源的動作後，您已經改變、並重新設定了 ST2 的 RAID。

6. 燈號說明

狀態	硬碟狀態燈		
	RAID 0, BIG,	RAID 1	JBOD
硬碟閒置	藍燈恆亮	藍燈恆亮	藍燈恆亮
無硬碟	紅燈恆亮	紅燈恆亮	紅燈恆亮
硬碟故障	紅燈閃爍	紅燈閃爍	N/A
RAID 降級	紅燈閃爍	紅燈閃爍	N/A
資料存取	藍燈閃爍	藍燈閃爍	藍燈閃爍
資料重建 - 來源碟	N/A	呼吸燈 (藍燈)	N/A
資料重建 - 目標碟	N/A	呼吸燈 (紫燈)	N/A

7. 更換硬碟與資料重建說明

1. 使用 ST2 過程當中，如硬碟故障而必須更換新硬碟時，請參考「[章節 4_ 硬體安裝](#)」，取出故障硬碟並更換成新硬碟。故障硬碟一旦完成更新並開機後，ST2 會自動進行資料重建功能。
2. 在資料重建的過程當中，如其中硬碟又再次發生故障，而導致資料重建無法繼續。請將 ST2 重新開機，再次確認硬碟是否故障，如果確定有故障，請參考「[章節 4_ 硬體安裝](#)」進行硬碟更換。

注意：

ST2 容許資料重建過程中斷。如您在資料重建過程中將電源關閉，在您下次開機，過程將會從您上次關機時的階段繼續進行直到完成。請勿任意改變硬碟的位置與順序。

8. 外接磁碟安裝作業系統

安裝 macOS (以 10.14 Mojave 為例)

1. 需具備網路連線能力。若有無線網路可用，可以從選單列的 Wi-Fi 選單中選擇該網路。「macOS 復原」也提供這份選單使用。
2. 開啟 Mac 並立即按住 **Command(⌘)-R**，持續按住這些按鍵，直到出現 Apple 標誌或旋轉的地球。看到工具程式視窗，即表示完成啟動：



3. 若必須在安裝 macOS 之前清除磁碟，請從「工具程式」視窗選擇「磁碟工具程式」，然後按一下「繼續」。您可能不需要清除磁碟，除非要將 Mac 賣或送給別人，或是有問題需要清除磁碟。



4. 安裝 macOS，在「工具程式」視窗中，選擇「重新安裝 macOS」，按一下「繼續」。



5. 按照螢幕上的指示，選擇同意軟體許可協議，然後選擇磁碟，開始安裝。



6. 請不要讓 Mac 進入睡眠或關上上蓋，以利安裝程序順利完成。安裝期間，Mac 可能會重新啟動並顯示進度列好幾次，而螢幕畫面也可能會一次空白幾分鐘時間。

安裝 Windows (以 Windows 10 家庭版為例)

1. 以下內容為使用工具軟體「WinToUSB 免費版」作為範例，相關規範與版權請到[軟體官網](#)詳閱說明。
2. 軟體安裝後，連續按兩下桌面的捷徑圖示，開啟 Hasleo WinToUSB。



3. 在界面左方選擇「鏡像到 USB」，再點選右方資料夾圖示來選擇 Windows 10 的 ISO 檔。



4. 選擇要安裝的 Windows 版本，執行下一步。



註：WinToUSB 免費版不支援 Windows 專業版與企業版。

5. 選擇要安裝的 USB 外接硬碟。

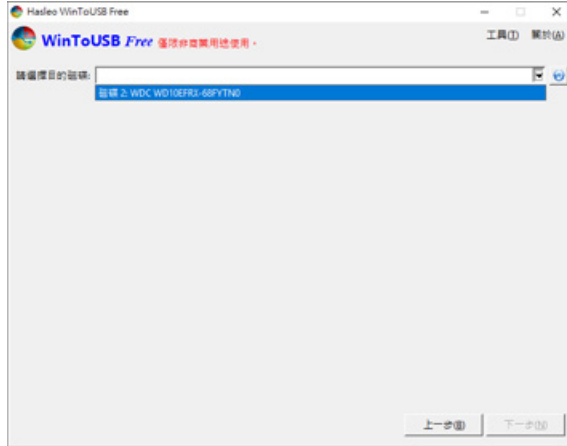

6. 依照個人硬體規格選擇磁碟分割配置的版本，之後執行「是」進行下一個的步驟。



7. 依照預設值，執行下一步。

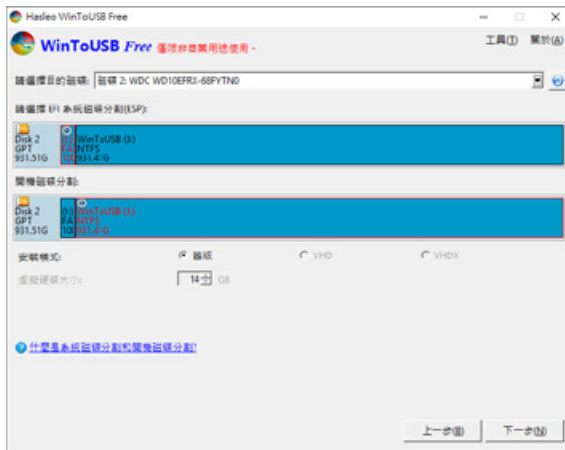

8. Windows 10 安裝到外接硬碟，待安裝完成後點選「結束」按鈕，之後再確認離開。



9. 確認外接硬碟插在電腦的 USB 插槽，重新開機後，進入 BIOS 或是 UEFI 調整成 USB 外接硬碟盒為第一開機順序，儲存設定後離開。

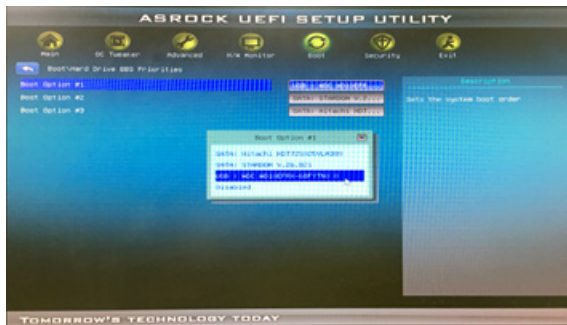

註：截圖僅為示意，實際情況依各家主機板而有所不同。

10. 接著開始進入 Windows 10 的安裝過程，請依系統指示以及個人需求完成設定。



<http://www.stardom.com.tw/>

