

12Gb/s SAS RAID Cards

ARC-1883 Series

(PCIe 3.0 to 12Gb/s SAS RAID Controllers)

Quick Start Guide

Version: 1.3

Issue Date: December, 2014

Copyright and Trademarks

The information regarding products in this manual is subject to change without prior notice and does not represent a commitment on the part of the vendor, who assumes no liability or responsibility for any errors that may appear in this manual. All brands and trademarks are the properties of their respective owners. This manual contains materials protected under International Copyright Conventions. All rights reserved. No part of this manual may be reproduced in any form or by any means, electronic or mechanical, including photocopying, without the written permission of the manufacturer and the author.

FCC Statement

This equipment has been tested and found to comply with the limits for a Class B digital device, pursuant to part 15 of the FCC Rules. These limits are designed to provide reasonable protection against interference in a residential installation. This equipment generates, uses, and can radiate radio frequency energy and, if not installed and used in accordance with the instructions, may cause harmful interference to radio communications. However, there is no guarantee that interference will not occur in a particular installation.

Manufacturer's Declaration for CE Certification

We confirm ARC-1883 has been tested and found compliant with the requirements in the council directive relating to the EMC Directive 2004/108/EC. Regarding to the electromagnetic compatibility, the following standards were applied:

EN 55022: 2006, Class B
EN 61000-3-2: 2006
EN 61000-3-3: 1995+A1: 2001+A2: 2005

EN 55024:1998+A1:2001=A2:2003
IEC61000-4-2: 2001
IEC61000-4-3: 2006
IEC61000-4-4: 2004
IEC61000-4-5: 2005
IEC61000-4-6: 2006
IEC61000-4-8: 2001
IEC61000-4-11: 2004

Contents

1. Introduction	4
1.1 Overview	4
1.2 Features	6
2. Hardware Installation	10
2.1 Before You First Installing.....	10
2.2 Board Layout.....	10
2.3 Installation.....	16
2.4 SAS Cables	25
2.4.1 Mini SAS HD SFF-8643 to 4xSATA Cable	25
2.4.2 Mini SAS HD SFF-8643 to 4xSFF-8482 Cable.....	26
2.4.3 Mini SAS HD SFF-8643 Cable	26
2.4.4 Mini SAS HD SFF-8644 Cable	27
2.5 LED Cables.....	27
2.5.1 Recognizing a Drive Failure.....	31
2.5.2 Replacing a Failed Drive	31
2.6 Summary of the installation.....	32

INTRODUCTION

1. Introduction

This section presents a brief overview of the 12Gb/s SAS RAID controller, ARC-1883 series. (PCIe 3.0 to 12Gb/s SAS RAID controllers)

1.1 Overview

The 12Gb/s SAS interface supports both 12Gb/s SAS disk drives for data-intensive applications and 6Gb/s SATA drives for low-cost bulk storage of reference data. The ARC-1883 family includes 8 ports low profile as well as 12/16/24 internal ports with additional 4 external ports models. The ARC-1883LP/1883i/1883x support eight 12Gb/s SAS ports via one internal & one external/two internal/two external Mini SAS HD connector. The ARC-1883ix-12/16/24 attaches directly to SATA/SAS midplanes with 3/4/6 Mini SAS HD SFF-8643 internal connector or increase capacity using one additional Mini SAS HD SFF-8644 external connector. When used with 12Gb/s SAS expanders, the controller can provide up to (256) devices through one or more 12Gb/s SAS JBODs, making it an ideal solution for enterprise-class storage applications that called for maximum configuration flexibility.

ARC-1883i/LP/x 12Gb/s RAID controllers are low-profile PCIe cards, ideal for 1U and 2U rack-mount systems. These controllers utilize the same RAID kernel that has been field-proven in existing external RAID controller products, allowing Areca to quickly bring stable and reliable PCIe 3.0 12Gb/s SAS RAID controllers to the market.

Unparalleled Performance for 12Gb/s SAS

The 12Gb/s SAS RAID controllers raise the standard to higher performance levels with several enhancements including new high performance 1.2 GHz dual core ROC processor, a DDR3-1866 memory architecture and high performance PCIe 3.0 interface bus interconnection. The low profile controllers by default support on-board 2G of ECC DDR3-1866 SDRAM memory. ARC-1883ix-12/16/24 RAID controllers each include one 240-pin DIMM socket with default 2GB DDR3-1866, single rank, 1Rx8, upgrade to 8GB or 8GB DDR3-1600, dual rank, 2Rx8, ECC SDRAM. The 12Gb/s SAS is designed for backward compatibility with 6Gb/s and 3Gb/s SAS/SATA hard

INTRODUCTION

drives. Regardless of the drive speed, 12Gb/s SAS RAID controllers will provide maximum read/write performance improvements for the most performance-hungry database and IT applications.

The ARC-1883ix includes one 12Gb/s SAS expander that incorporates the latest enhancements in SAS along with new LSI DataBolt bandwidth optimizer technology. This is designed to help facilitate the industry transition to 12Gb/s SAS-enabled systems by allowing users to take advantage of 12Gb/s speeds while utilizing existing 6Gb/s drives and backplanes. Using DataBolt, the ARC-1883ix buffers 6Gb/s data and then transfers it out to the host at 12Gb/s speeds in order to match the bandwidth between faster hosts and slower SAS or SATA devices

Unsurpassed Data Availability

Designed and leveraged with Areca's existing high performance RAID solution, ARC-1883 provides superior levels performance and enterprise level data protection for the most demanding next-generation server and storage environments. It supports the hardware RAID 6 engine to allow two HDDs failures without impact the existing data and performance. It allows users to hot swap drive in the event of a drive failure with zero downtime. The optional flash-based backup module provides power to transfer the cache data from the SDRAM memory to the NAND flash memory if it contains data not yet written to the drives when power is lost. ARC-1883 also supports traditional Lithium-ion (Li-ion) battery backup module (BBM) to protect cached data on RAID adapters. Board-level hardware encryption manages any kinds of drives attached to ARC-1883 controller cards for higher levels of security. API code supports for third-party Enterprise Key Management systems to easy integrate and manage encryption function.

Maximum Interoperability

The 12Gb/s SAS RAID controller support broad operating system including Windows, Linux (Open Source), FreeBSD (Open Source), Solaris (Open Source), Mac, VMware and more, along with key system monitoring features such as enclosure management (SES-2, SMP, & SGPIO) and SNMP function. Our products and technology are based on extensive testing and validation process; leverage

INTRODUCTION

ARC-1880/1882 series controller field-proven compatibility with operating systems, motherboards, applications and device drivers.

Easy RAID Management

The controllers contain an embedded McBIOS RAID manager that can access via hot key at M/B BIOS boot-up screen. This pre-boot McBIOS RAID manager can use to simplify the setup and management of RAID controller. The controller firmware also contains a browser-based McRAID storage manager which can be accessed through the Ethernet port or ArchHTTP proxy server in Windows, Linux, FreeBSD and more environments. The McRAID storage manager allows local and remote for all storage configuration and management needs from standard web browser. The Single Admin Portal (SAP) monitor utility can support one application to scan multiple Areca RAID units in the network.

1.2 Features

Controller Architecture

- Dual core RAID-on-Chip (ROC) 1.2GHz processor
- PCIe 3.0 x8 lane host interface
- 2GB on-board DDR3-1866 SDRAM with ECC (ARC-1883i/LP/x)
- One 240-pin DIMM socket for 2GB(default) DDR3-1866, 1RX8, ECC module (ARC-1883ix-12/16/24)
 - up to 4GB or 8GB DDR3-1866, 1RX8, Unbuffered/Registered ECC module or
 - up to 4GB or 8GB DDR3-1600, 2RX8, Unbuffered/Registered ECC module
- Write-through or write-back cache support
- Support up to 4/8/12/16/24 internal or 4/8 external 12Gb/s SAS ports
- Multi-adapter support for large storage requirements
- BIOS boot array support for greater fault tolerance
- Supports up to 256 SATA or SAS devices using SAS expanders
- Boot support for the uEFI host BIOS
- DataBolt™ Bandwidth Optimizer for balance faster host and slower SAS or SATA devices. (for ARC-1883ix)
- Redundant flash image for controller availability
- Support flash-based or battery backup module (FBM/BBM) ready (optional)

INTRODUCTION

- RoHS compliant

RAID Features

- RAID level 0, 1, 10(1E), 3, 5, 6, 30, 50, 60, Single Disk or JBOD
- Multiple RAID 0 and RAID 10(1E) support (RAID 00 and RAID100)
- Multiple RAID selection
- Configurable stripe size up to 1024KB
- Support HDD firmware update
- Online array roaming
- Online RAID level/stripe size migration
- Online capacity expansion and RAID level migration simultaneously
- Online volume set growth
- Instant availability and background initialization
- Support global and dedicated hot spare
- Automatic drive insertion/removal detection and rebuilding
- Support for native 4K and 512 byte sector SAS and SATA devices
- Multiple pairs SSD/HDD disk clone function
- SSD automatic monitor clone (AMC) support
- Controller level hardware encryption support
- Support intelligent power management to save energy and extend service life

Monitors/Notification

- System status indication through global HDD activity/fault connector, individual activity/fault connector, LCD/I2C connector and alarm buzzer
- SMTP support for email notification
- SNMP support for remote manager
- Enclosure management (SES-2, SMP and SGPIO) ready

RAID Management

- Field-upgradeable firmware in flash ROM

In-Band Manager

- Hot key "boot-up" McBIOS RAID manager via M/B BIOS
- Web browser-based McRAID storage manager via ArchHTTP proxy server for all operating systems
- Support Command Line Interface (CLI)
- API library for customer to write monitor utility
- Single Admin Portal (SAP) monitor utility

INTRODUCTION

Out-of-Band Manager

- Firmware-embedded web browser-based McRAID storage manager, SMTP manager, SNMP agent and Telnet function via Ethernet port
- API library for customer to write monitor utility
- Support push button and LCD display panel (optional)

Operating System

- Windows 8/Server 2012/7/2008/Vista/XP/2003
- Linux
- FreeBSD
- VMware (only driver package available w/o in-band management utility)
- Solaris 10/11 x86/x86_64
- Mac OS X 10.4.x or higher

(For latest supported OS listing visit <http://www.areca.com.tw>)

12Gb/s SAS RAID Controllers			
Model Name	ARC-1883i	ARC-1883LP	ARC-1883x
I/O Processor	Dual Core RAID-on-Chip 1.2GHz		
Form Factor (H x L)	Low Profile: 64.4 x 169.5 mm		
Host Bus Type	PCIe 3.0 x 8 Lanes		
Driver Connector	2xSFF-8643	1xSFF-8643 1xSFF-8644	2xSFF-8644
Drive Support	Up to 256 12Gb/s SAS or 6Gb/s and 3Gb/s SAS/SATA HDDs		
FBM/BBM Support	ARC-1883-CAP /ARC-1883-BAT / ARC-6120BA-T121-12G		
RAID Level	0, 1, 1E, 3, 5, 6, 10, 30, 50, 60, Single Disk, JBOD		
On-Board Cache	2GB on-board DDR3-1866 SDRAM		
Management Port	In-Band: PCIe Out-of-Band: BIOS, LCD, LAN Port		
Enclosure Ready	Individual Activity/Faulty Header, SGPIO, SMP, SES-2		

INTRODUCTION

12Gb/s SAS RAID Controllers			
Model Name	ARC-1883ix-12	ARC-1883ix-16	ARC-1883ix-24
I/O Processor	Dual Core RAID-on-Chip 1.2GHz		
Form Factor (H x L)	Full Height: 98.4 x 254 mm		
Host Bus Type	PCIe 3.0 x 8 Lanes		
Driver Connector	3xSFF-8643 1xSFF-8644	4xSFF-8643 1xSFF-8644	6xSFF-8643 1xSFF-8644
Drive Support	Up to 256 12Gb/s SAS or 6Gb/s and 3Gb/s SAS/SATA HDDs		
FBM/BBM Support	ARC-1883-CAP (support default cache 2GB) / ARC-1883-BAT (support cache 2GB, 4GB or 8GB) / ARC-6120BA-T121-12G		
RAID Level	0, 1, 1E, 3, 5, 6, 10, 30, 50, 60, Single Disk, JBOD		
On-Board Cache	One 240-pin DIMM socket for 2GB(default) DDR3-1866, 1RX8, ECC module - up to 4GB or 8GB DDR3-1866, 1RX8, Unbuffered/Registered ECC module or - up to 4GB or 8GB DDR3-1600, 2RX8, Unbuffered/Registered ECC module		
Management Port	In-Band: PCIe Out-of-Band: BIOS, LCD, LAN Port		
Enclosure Ready	Individual Activity/Faulty Header, SGPIO, SMP, SES-2		

HARDWARE INSTALLATION

2. Hardware Installation

This section describes the procedures for installing the 12Gb/s SAS RAID controllers.

2.1 Before You First Installing

Thanks for purchasing the 12Gb/s SAS RAID controller as your RAID data storage subsystem. This user manual gives simple step-by-step instructions for installing and configuring the 12Gb/s SAS RAID controller. To ensure personal safety and to protect your equipment and data, reading the following information package list carefully before you begin installing.

Package Contents

If your package is missing any of the items listed below, contact your local dealers before you install. (**Disk drives and disk mounting brackets are not included**)

- 1 x 12Gb/s SAS RAID controller in an ESD-protective bag
- 1 x Installation CD – containing driver, relative software, an electronic version of this manual and other related manual
- 1 x User manual
- Adapter convert two 4 pin peripheral power cables into a PCI-E power cable (ARC-1883ix only)
- 1 x Low-profile bracket

Note:

Low-profile bracket has included on the low profile board shipping package.

2.2 Board Layout

The controller can support a family included 8 ports models as well as industry-first 8/12/16/24 internal ports with additional 4 external ports. This section provides the board layout and connector/jumper for the 12Gb/s SAS RAID controller.

HARDWARE INSTALLATION

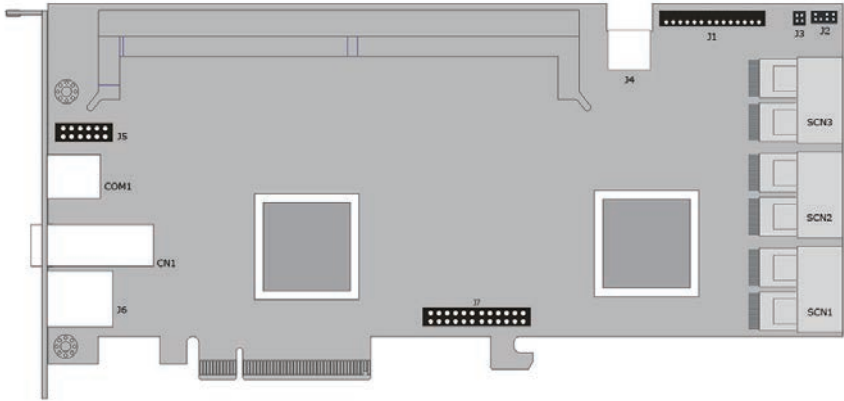

Figure 2-1, ARC-1883ix-12/16/24 Top View

Connector	Type	Description
1. (J1)	Flash-based/Battery Backup Module Connector	14-pin box header
2. (J2)	I ² C/LCD Connector	7-pin header
3. (J3)	Global Fault/Activity LED	4-pin header
4. (J4)	PCI-E Power Connector	6-pin header
5. (J5)	Manufacture Purpose Port	12-pin header
6. (J6)	Ethernet Port	RJ45
7. (J7)	Individual Fault LED Header	24-pin header
8. (COM1)	RS232 Port for CLI to configure the expander functions on the RAID controller (*1)	RJ11 connector
9. (CN1)	Mini SAS HD 25-28 Ports (External)	SFF-8644
10. (SCN1)	Mini SAS HD 1-8 Ports (Internal)	SFF-8643
11. (SCN2)	Mini SAS HD 9-16 Ports (Internal)	SFF-8643
12. (SCN3)	Mini SAS HD 17-24 Ports (Internal)	SFF-8643

Table 2-1, ARC-1883ix-12/16/24 Connectors

Note:

You can download the ARC1882ix_1883ix Expander-CLI.PDF manual from "<http://www.areca.com.tw/support/main.htm>" to view and set expander configuration.

HARDWARE INSTALLATION

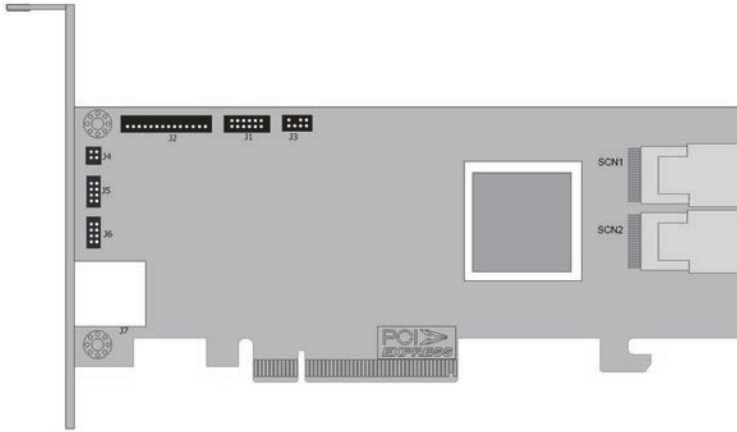

Figure 2-2, ARC-1883i Top View

Connector	Type	Description
1. (J1)	Manufacture Purpose Port	12-pin header
2. (J2)	Flash-based/Battery Backup Module Connector	14-pin box header
3. (J3)	I ² C/LCD Connector	7-pin header
4. (J4)	Global Fault/Activity LED	4-pin header
5. (J5)	Individual Activity (HDD) LED Header	4-pin header
6. (J6)	Individual Fault LED Header	4-pin header
7. (J7)	Ethernet Port	RJ45
8. (SCN1)	Mini SAS HD 1-4 Ports (Internal)	SFF-8643
9. (SCN2)	Mini SAS HD 5-8 Ports (Internal)	SFF-8643

Table 2-2, ARC-1883i Connectors

HARDWARE INSTALLATION

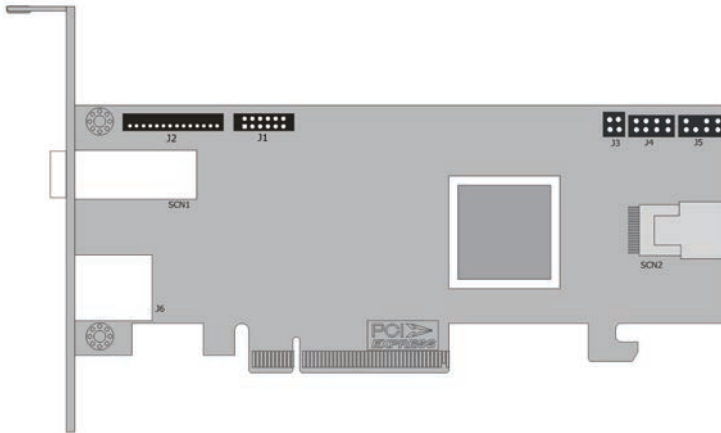

Figure 2-3, ARC-1883LP Top View

Connector	Type	Description
1. (J1)	Manufacture Purpose Port	12-pin box header
2. (J2)	Flash-based/Battery Backup Module Connector	14-pin header
3. (J3)	Global Fault/Activity LED	4-pin header
4. (J4)	Individual Fault/Activity LED Header	8-pin header
5. (J5)	I ² C/LCD Connector	7-pin header
6. (SCN1)	Mini SAS HD 5-8 Ports (External)	SFF-8644
7. (SCN2)	Mini SAS HD 1-4 Ports (Internal)	SFF-8643
8. (J6)	Ethernet Port	RJ45

Table 2-3, ARC-1883LP Connectors

HARDWARE INSTALLATION

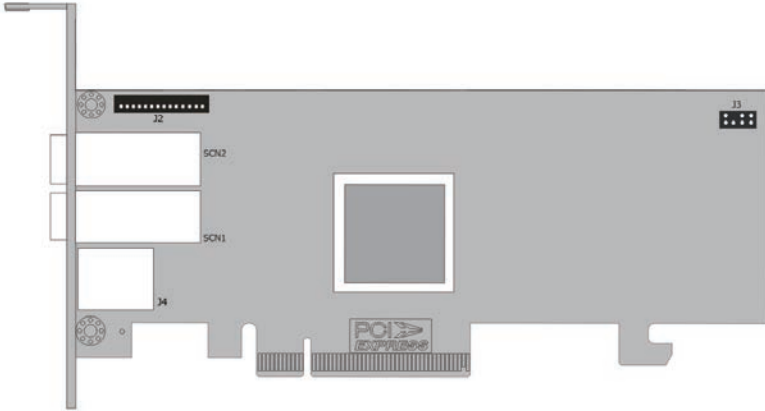
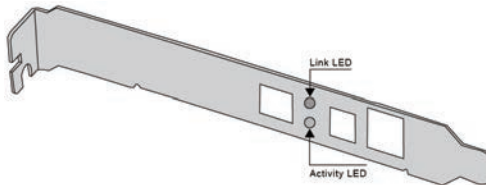

Figure 2-4, ARC-1883x Top View

Connector	Type	Description
1. (J2)	Flash-based/Battery Backup Module Connector	14-pin box header
2. (J3)	I ² C/LCD Connector	7-pin header
3. (J4)	Ethernet Port	RJ45
4. (SCN1)	Mini SAS HD 5-8 Ports (External)	SFF-8644
5. (SCN2)	Mini SAS HD 1-4 Ports (External)	SFF-8644

Table 2-4, ARC-1883x Connectors

The following table describes the ARC-1883ix external port Mini SAS HD SFF-8644 link/activity LED behavior.



LED	Status
Link LED (Green light)	When the link LED is lit that indicates the link LED is connected.
Activity LED (Blue light)	The activity LED is lit that indicates the adapter is active.

HARDWARE INSTALLATION

Tools Required

An ESD grounding strap or mat is required. Also required are standard hand tools to open your system's case.

System Requirement

The 12Gb/s SAS RAID controller can be installed in an universal PCIe slot and requires a motherboard that:

ARC-1883 series 12Gb/s SAS RAID controller requires:

- Comply with the PCIe 3.0 x8 lanes
It can work on the PCIe 3.0 x1, x4, x8, and x16 signal with x8 or x16 mechanical slot M/B.
- Backward-compatible with PCIe 1.0/2.0

Installation Tools

The following items may be needed to assist with installing the 12Gb/s SAS RAID controller into an available PCIe expansion slot.

- Small screwdriver
- Host system hardware manuals and manuals for the disk or enclosure being installed

Personal Safety Instructions

Use the following safety instructions to help you protect your computer system from potential damage and to ensure your own personal safety.

- Always wear a grounding strap or work on an ESD-protective mat.

Warning:

High voltages may be found inside computer equipment. Before installing any of the hardware in this package or removing the protective covers of any computer equipment, turn off power switches and disconnect power cords. Do not reconnect the power cords until you have replaced the covers.

HARDWARE INSTALLATION

- Before opening the system cover, turn off power switches and unplug the power cords. Do not reconnect the power cords until you have replaced the covers.

Electrostatic Discharge

Static electricity can cause serious damage to the electronic components on this 12Gb/s SAS RAID controller. To avoid damage caused by electrostatic discharge, observe the following precautions:

- Do not remove the 12Gb/s SAS RAID controller from its anti-static packaging until you are ready to install it into a computer case.
- Handle the 12Gb/s SAS RAID controller by its edges or by the metal mounting brackets at its each end.
- Before you handle the 12Gb/s SAS RAID controller in any way, touch a grounded, anti-static surface, such as an unpainted portion of the system chassis, for a few seconds to discharge any built-up static electricity.

2.3 Installation

Use the instructions below to install a 12Gb/s SAS RAID controller.

Step 1. Unpack

Unpack and remove the 12Gb/s SAS RAID controller from the package. Inspect it carefully, if anything is missing or damaged, contact your local dealer.

Step 2. Power PC/Server Off

Turn off computer and remove the AC power cord. Remove the system's cover. For the instructions, please see the computer system documentation.

Step 3. Check Memory Module (ARC-1883ix only)

Be sure of the cache memory module is present and seated firmly in the 240-pin DIMM socket for ARC1883ix-12/16/24 models. The

HARDWARE INSTALLATION

physical memory configuration for ARC-1883ix series is one 240-pin DIMM socket for 2GB(default) up to 8GB DDR3-1866, 1Rx8, ECC module or 8GB, DDR3-1600, 2Rx8, ECC module.

Step 4. Install the 12Gb/s SAS RAID Controllers

To install the 12Gb/s SAS RAID controller, remove the mounting screw and existing bracket from the rear panel behind the selected PCIe 3.0 slot. Align the gold-fingered edge on the card with the selected PCIe 3.0 slot. Press down gently but firmly to ensure that the card is properly seated in the slot, as shown in Figure 2-5. Then, screw the bracket into the computer chassis. ARC-1883 series controllers require a PCIe 3.0 x8 slot for better performance.

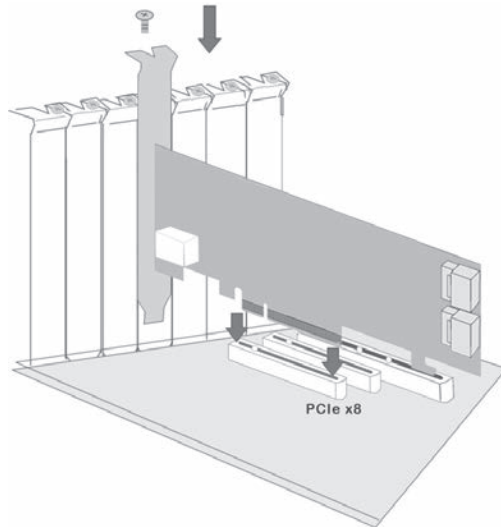

Figure 2-5, Insert into a PCIe Slot

Step 5. Mount the Drives

You can connect the SAS/SATA drives to the controller through direct cable and backplane solutions. In the direct connection, SAS/SATA drives are directly connected to 12Gb/s SAS RAID controller PHY port with SAS/SATA cables. The 12Gb/s SAS RAID controller can support up to 28 PHY ports. Remove the front bezel from the computer chassis and install the cages or SAS/SATA drives in the computer chassis. Loading drives to the drive tray if cages are

HARDWARE INSTALLATION

installed. Be sure that the power is connected to either the cage backplane or the individual drives.

In the backplane solution, SAS/SATA drives are directly connected to 12Gb/s SAS system backplane or through an expander board. The number of SAS/SATA drives is limited to the number of slots available on the backplane. Some backplanes support daisy chain expansion to the next backplanes. The 12Gb/s SAS RAID controller can support daisy-chain up to 8 enclosures. The maximum drive no. is 256 devices through 8 enclosures. The following figure shows how to connect the external Mini SAS HD SFF-8644 cable from the 12Gb/s SAS RAID controller that has external connectors to the external drive boxes or drive enclosures.

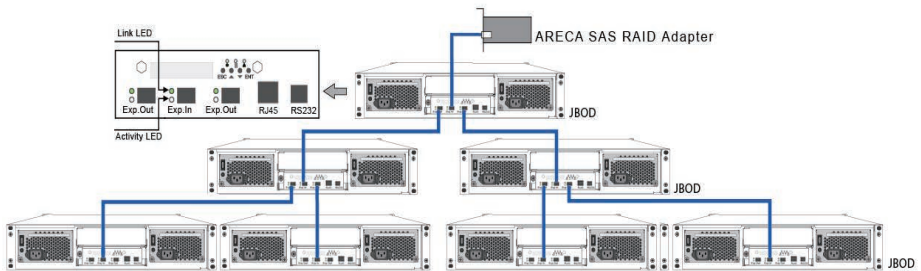

Figure 2-6, Connecting to Drive Enclosure

The following table shows the maximum number of 12Gb/s SAS RAID controller supported:

	Disks/Enclosure	Expander	Disks/Controller	Volume
Max No.	128	8	256	128

Note:

The maximum no. is 32 disk drives included in a single RAID set.

HARDWARE INSTALLATION

Step 6. Install SAS Cable

This section describes how to cable a controller to the drive or backplane.

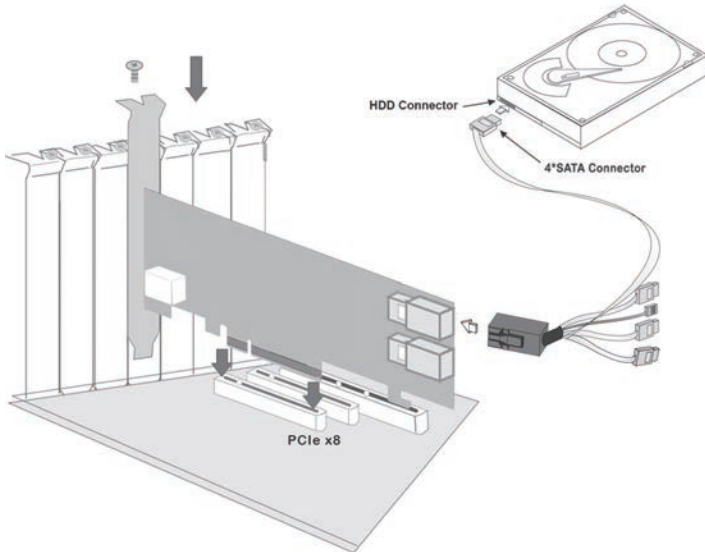

Figure 2-7, Connecting to HDD

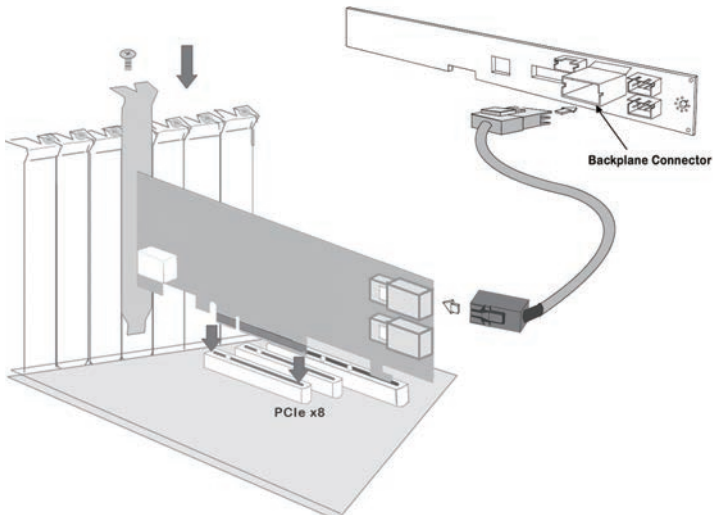

Figure 2-8, Connecting to Backplane

HARDWARE INSTALLATION

Step 7. Connect Power to the Controller (ARC-1883ix only)

There is a 6-pin PCI-E connector on the ARC-1883ix labelled J4. You must plug in a PSU's PCI-E cable at all times to supply enough stable power for the controller.

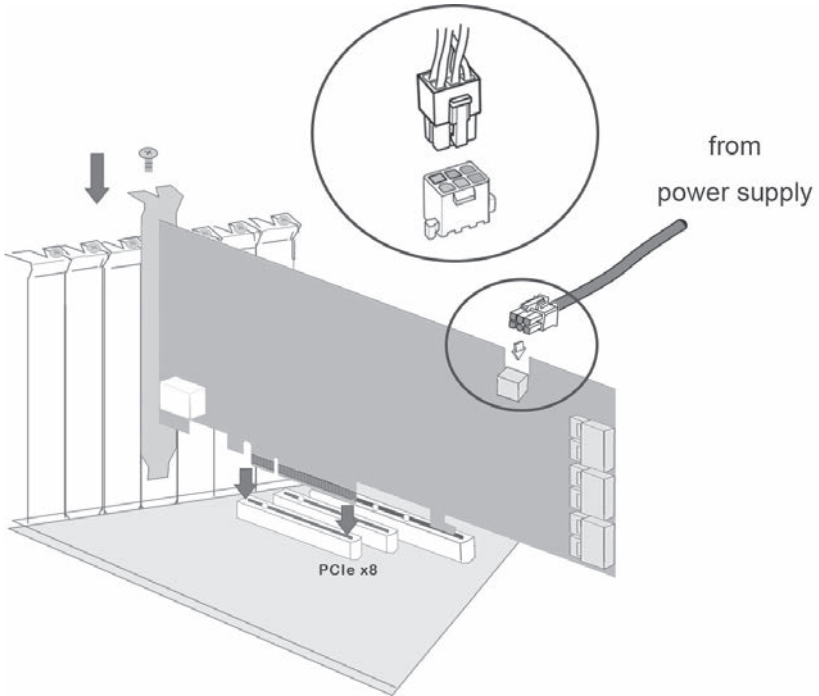

Figure 2-9, Connect Direct from Power Supply

If your power supply doesn't have a 6 pin PCI-E power cable then you can use the adapter to convert two 4 pin peripheral power cables into a PCI-E power cable. If you use an adapter then be sure to plug the 4 pin peripheral power connectors into separate power cables coming from the power supply.

HARDWARE INSTALLATION

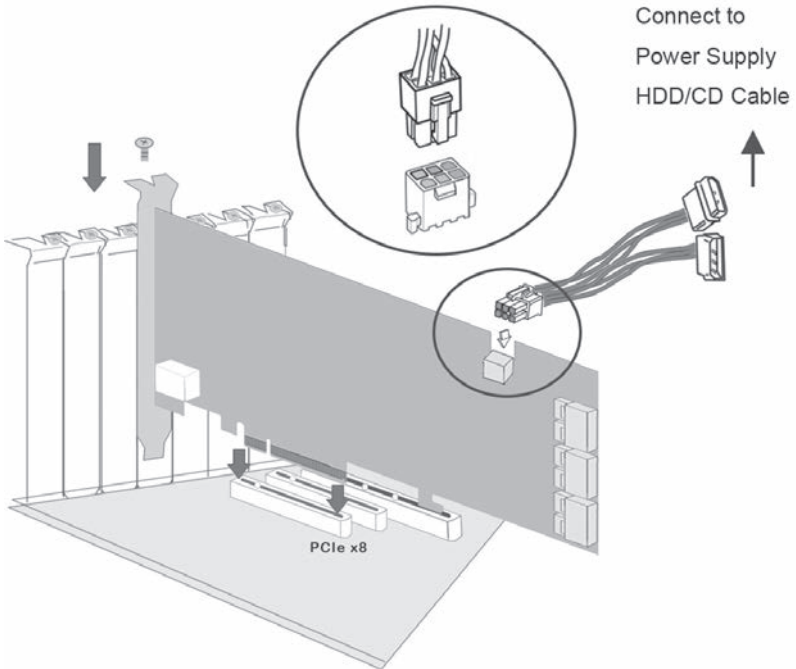

Figure 2-10, Connect through HDD/CD Cable

Step 8. Install the LED Cable (Optional)

The preferred I/O connector for server backplanes is the Mini SAS HD SFF-8643 connector. This connector has eight signal pins to support four SAS/SATA drives and six pins for the SGPIO (Serial General Purpose Input/Output) side-band signals. The SGPIO bus is used for efficient LED management and sensing drive locate status. See SFF 8485 for the specification of the SGPIO bus. For backplane without enclosure SGPIO support, please refer to section 2.4 LED cables for fault/activity LED cable installation.

LED Management: The backplane may contain LEDs to indicate drive status. Light from the LEDs could be transmitted to the outside of server by using light pipes mounted on the SAS drive tray. A small microcontroller on the backplane, connected via the SGPIO bus to a 12Gb/s SAS RAID controller, could control the LEDs. **Activity:** blinking 5 times/second and **Fault:** lit

HARDWARE INSTALLATION

Drive Locate: The location of a drive may be detected by sensing the voltage level of one of the pre-charge pins before and after a drive is installed.

The following signals define the SGPIO assignments for the Mini SAS HD SFF-8643 in the 12Gb/s SAS RAID controller.

Pin	Description	Pin	Description
SideBand0	SClock (Clock signal)	SideBand1	SLoad (Last clock of a bit stream)
SideBand2	Ground	SideBand3	Ground
SideBand4	SDataOut (Serial data output bit stream)	SideBand5	SDataIn (Serial data input bit stream)
SideBand6	Reserved	SideBand7	Reserved

The Mini SAS HD SFF-8643 to 4xSATA with sideband cable follows the SFF-8448 specification. The SFF-8448 sideband signals cable is reserved for the backplane with header on it. The following signal defines the sideband connector which can work with Areca sideband cable on its Mini SAS HD SFF-8643 to 4xSATA cable.

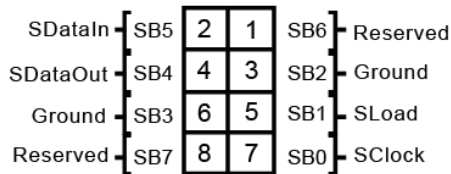

Sideband Pin Definitions

The sideband header is located at backplane. For SGPIO to work properly, please connect the 8-pin sideband cable to the sideband header as shown above.

Step 9. Adding a FBM/BBM Backup Module (Optional)

Please refer to Appendix B and Appendix C of the user manual for installing the flash-based/battery backup module (FBM/BBM) in your 12Gb/s SAS RAID controller.

Step 10. Re-check Fault LED Cable Connections (Optional)

Be sure that the proper failed drive channel information is displayed by the fault LEDs. An improper connection will light the

HARDWARE INSTALLATION

wrong LED which causes the user to hot swap the wrong drive. This could result in failure and loss of system data.

Step 11. Power up the System

Thoroughly check the installation, reinstall the computer cover, and reconnect the power cord cables. Turn on the power switch at the rear of the computer (if equipped) and then press the power button at the front of the host computer.

Step 12. Install the Controller Driver

For a new system:

- Driver installation usually takes place as part of operating system installation. Please refer to Chapter 4 "Driver Installation" of the user manual for the detailed installation procedure.

In an existing system:

- To install the controller driver into the existing operating system. For the detailed installation procedure, please refer to the Chapter 4 "Driver Installation" of the user manual.

Step 13. Install ArcHTTP Proxy Server

The 12Gb/s SAS RAID controller firmware has embedded the web-browser McRAID storage manager. ArcHTTP proxy server will launch the web-browser McRAID storage manager. It provides all of the creation, management and monitor 12Gb/s SAS RAID controller status. Please refer to the Chapter 5 of the user manual for the detail ArcHTTP Proxy Server Installation. For SNMP agent function, please refer to Appendix D of the user manual.

Step 14. Configure Volume Set

The controller configures RAID functionality through the McBIOS RAID manager. Please refer to Chapter 3 of the user manual, McBIOS RAID Manager, for the detail. The RAID controller can also be configured through the McRAID storage manager with ArcHTTP proxy server installed or through on-board LAN port and LCD module (refer to LCD manual). For McRAID storage manager option, please refer to Chapter 6 of the user manual, Web Browser-Based Configuration.

HARDWARE INSTALLATION

Step 15. Determining the Boot Sequences

For PC system:

12Gb/s SAS RAID controller is a bootable controller. If your system already contains a bootable device with an installed operating system, you can set up your system to boot a second operating system from the new controller. To add a second bootable controller, you may need to enter setup of motherboard BIOS and change the device boot sequence so that the new RAID controller heads the list. If the system BIOS setup does not allow this change, your system may be not configurable to allow the 12Gb/s SAS RAID controller to act as a second boot device.

For Intel-based Mac system:

Areca controller has supported the EFI BIOS on the PCIe 3.0 12Gb/s SAS RAID controller. You have other alternatively to add volumes on the Intel-based Mac bootable device listing. You can follow the following procedures to add 12Gb/s SAS RAID controller on the Mac bootable device listing.

1. Set the BIOS selection in System Controls: Advance Configuration to "EFI" option for Intel-based MacPro boot.
2. Download OS X Mavericks and DiskMaker X. Follow the DiskMaker X to make a bootable OS X Mavericks USB install drive.
3. Restart your Mac and after you hear the chime sound, press the Option (Alt) key until you see the option to choose the flash drive to boot from.
4. Follow the on-screen prompts to complete Areca Volume Upgrade and Clean Install of OS X Mavericks. Power up the Intel-based Mac and Areca volume will be added in the bootable device automatically.

HARDWARE INSTALLATION

2.4 SAS Cables

You can connect the end devices to each other through direct cables or through the SAS expander/backplane connections. The 12Gb/s SAS RAID controller supports daisy-chain expansion up to 8 enclosures. The following is an example of some internal SAS/SATA cables and an external SAS cable.

2.4.1 Mini SAS HD SFF-8643 to 4xSATA Cable

The Mini SAS HD SFF-8643 to 4xSATA cables are used for connection between the 12Gb/s SAS RAID controller internal connectors and connectors on the SAS/SATA disk drives or SAS/SATA connector backplane. The 12Gb/s SAS controllers have 1-6 Mini SAS HD SFF-8643 internal connectors, each of them can support up to four SAS/SATA drives.

These controllers can be installed in a server RAID enclosure with standard SATA connectors backplane. The following diagram shows the picture of Mini SAS HD SFF-8643 to 4xSATA cables. Backplane with SGPIO header can leverage the SGPIO function on the 12Gb/s SAS RAID controller through the sideband cable.

The SFF-8448 sideband signals cable is reserved for the backplane with header on it.

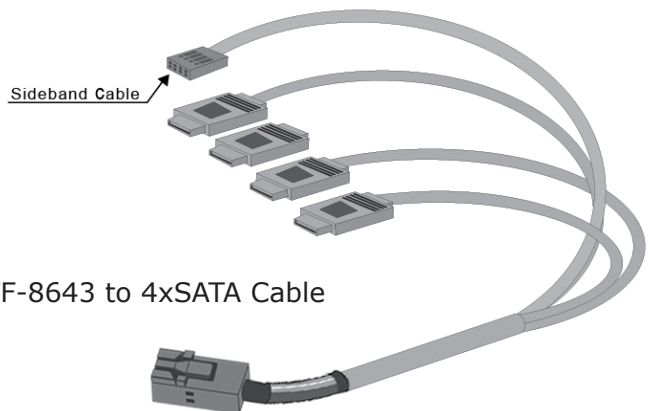

Figure 2-11, SFF-8643 to 4xSATA Cable

HARDWARE INSTALLATION

2.4.2 Mini SAS HD SFF-8643 to 4xSFF-8482 Cable

These controllers can be installed in a server RAID enclosure with out a backplane. The kind of cable will attach directly to the SAS disk drives. The following diagram shows the picture of Mini SAS HD SFF-8643 to 4xSFF-8482 cables.



Figure 2-12, SFF-8643 to 4xSFF-8482 Cable

2.4.3 Mini SAS HD SFF-8643 Cable

The 12Gb/s SAS RAID controllers have 1-6 Mini SAS HD SFF-8643 connectors, each of them can support up to four SAS/SATA signals. These controllers can be installed in a server RAID enclosure with Mini SAS HD SFF-8643 internal connectors backplane. This Mini SAS HD cable has eight signal pins to support four SAS/SATA drives and six pins for the SGPIO (Serial General Purpose Input/Output) side-band signals. The SGPIO bus is used for efficient LED management and sensing drive Locate status.

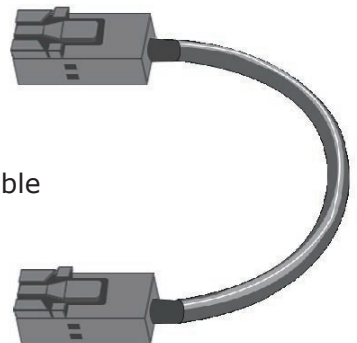

Figure 2-13, Mini SAS HD SFF-8643 Cable

HARDWARE INSTALLATION

2.4.4 Mini SAS HD SFF-8644 Cable

The Mini SAS HD SFF-8644 cables are used for connection between the 12Gb/s SAS controller external connectors and connectors on the external drive boxes or drive expanders (JBOD). The 12Gb/s SAS controller has Mini SAS HD SFF-8644 external connector, each of them can support up to four SAS/SATA signals.

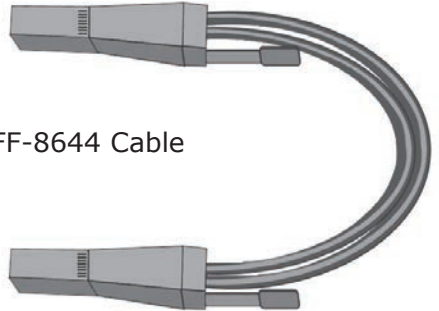
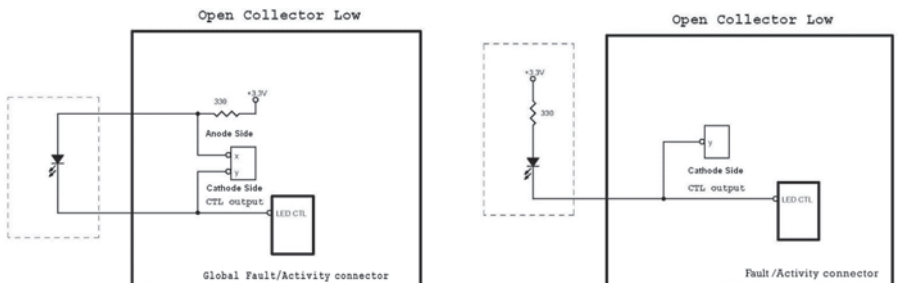

Figure 2-14, Mini SAS HD SFF-8644 Cable

2.5 LED Cables

There is no SGPIO supported in the most of old version SATA backplane. The 12Gb/s SAS controller also provides two kinds of alternative LED cable header to support the fault/activity status for those backplanes. The global indicator connector is used by the server global indicator LED.

The following electronics schematic is the 12Gb/s SAS RAID controller logical of fault/activity header. The signal for each pin is cathode (-) side. The following diagrams and descriptions describe each type of indicator connector.



HARDWARE INSTALLATION

1. Individual Activity/Fault LED and Global Indicator Connector

Most of the backplane has supported the HDD activity from the HDD. The 12Gb/s SAS RAID controller also provides the fault activity for fault LED. Connect the cables for the drive fault LEDs between the backplane of the cage and the respective connector on the 12Gb/s SAS RAID controller.

The following table is the fault LED signal behavior.

LED	Normal Status	Problem Indication
Fault LED	<ol style="list-style-type: none"> When the fault LED is lit, there is no disk present. When the fault LED is not lit, then disk is present and status is normal. 	<ol style="list-style-type: none"> When the fault LED is blinking (2 times/sec), that disk drive has failed and should be hot swapped immediately. When the activity LED is lit and fault LED is fast blinking (10 times/sec) there is rebuilding activity on that disk drive.

If the system will use only a single global indicator, attach the LED to the two pins of the global activity/fault connector. The global fault pin pair connector is the overall fault signal. This signal will light up in any disk drive failure.

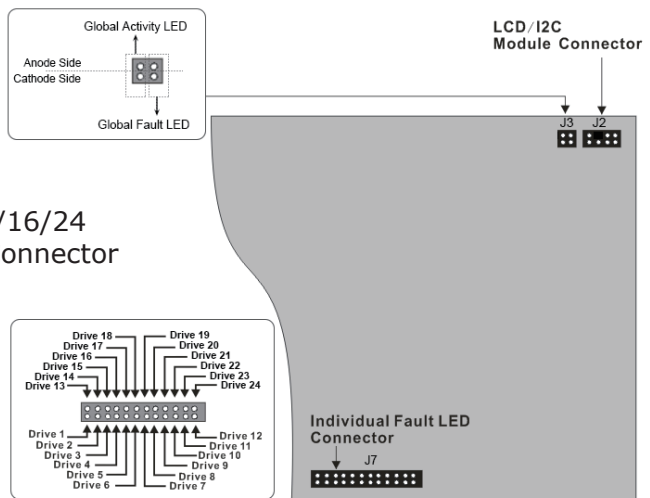

Figure 2-15,
ARC-1883ix-12/16/24
LED Indicator Connector

HARDWARE INSTALLATION

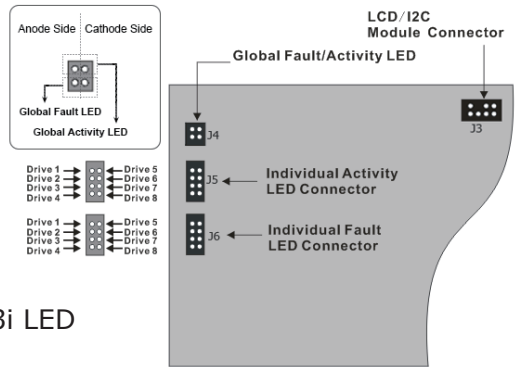

Figure 2-16, ARC-1883i LED Indicator Connector

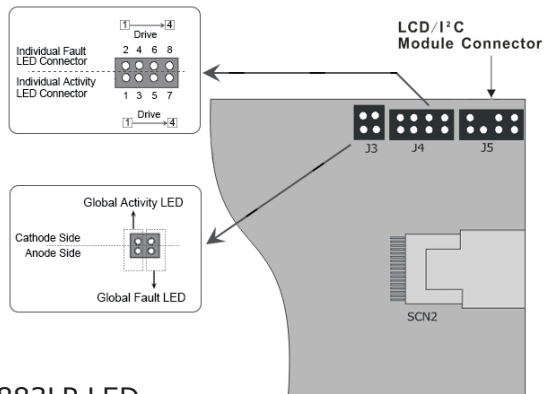

Figure 2-17, ARC-1883LP LED Indicator Connector

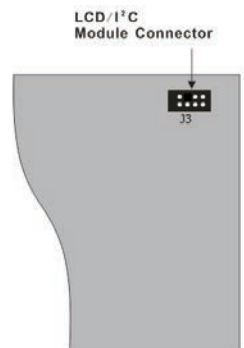

Figure 2-18, ARC-1883x LED Indicator Connector

HARDWARE INSTALLATION

Note:

A cable for the global indicator comes with your computer system. Cables for the individual drive LEDs may come with a drive cage, or you may need to purchase them.

2. Areca Serial Bus Connector

You can also connect the Areca interface to a proprietary SAS/SATA backplane enclosure. This can reduce the number of activity LED and/or fault LED cables. The I²C interface can also cascade to another SAS/SATA backplane enclosure for the additional channel status display.

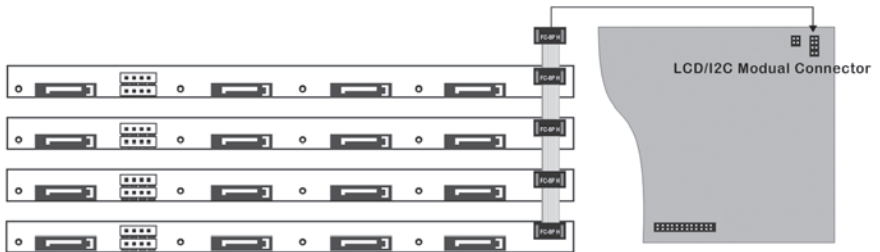
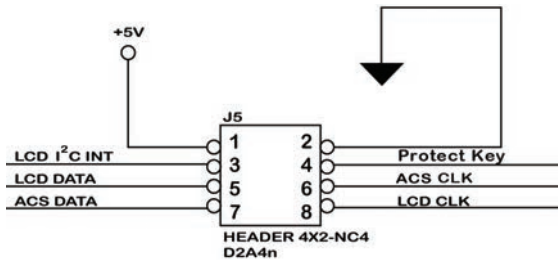

Figure 2-19, Serial Bus Connector for SATA Backplane.

The following picture and table are the serial bus signal name description for LCD & fault/activity LED.



Pin	Description	Pin	Description
1	Power (+5V)	2	GND
3	LCD Module Interrupt	4	Protect Key
5	LCD Module Serial Data	6	Fault/Activity Clock
7	Fault/Activity Serial Data	8	LCD Module Clock

HARDWARE INSTALLATION

Areca serial bus also supports SES (SCSI Enclosure Services) over I²C over internal I²C backplane cable. The backplane cable can connect the I²C signal from Areca controller to the backplane using IPMI-style I²C 3-pin connector. It means you link I²C cable into back plane, and let back plane LED indicate hard disk drive fail status.

2.5 Hot-plug Drive Replacement

The RAID controller supports the ability of performing a hot-swap drive replacement without powering down the system. A disk can be disconnected, removed, or replaced with a different disk without taking the system off-line. The RAID rebuilding will be processed automatically in the background. When a disk is hot swap, the RAID controller may no longer be fault tolerant. Fault tolerance will be lost until the hot swap drive is subsequently replaced and the rebuild operation is completed.

2.5.1 Recognizing a Drive Failure

A drive failure can be identified in one of the following ways:

1. An error status message lists failed drives in the event log.
2. A fault LED illuminates on the front of RAID subsystem if failed drives are inside.

2.5.2 Replacing a Failed Drive

With RAID subsystem drive tray, you can replace a defective physical drive while your computer is still operating. When a new drive has been installed, data reconstruction will be automatically started to rebuild the contents of the disk drive. The controller always uses the smallest hotspare that "fits". If a hotspare is used and the defective drive is exchanged on-line, the new inserted HDD will automatically assign as a hotspare HDD.

Note:

The capacity of the replacement drives must be at least as large as the capacity of the other drives in the raid set. Drives of insufficient capacity will be failed immediately by the RAID controller without starting the "Automatic Data Rebuild".

HARDWARE INSTALLATION

2.6 Summary of the installation

The flow chart below describes the installation procedures for 12Gb/s SAS RAID controllers. These procedures include hardware installation, the creation and configuration of a RAID volume through the McBIOS/McRAID manager, OS installation and installation of 12Gb/s SAS RAID controller software.

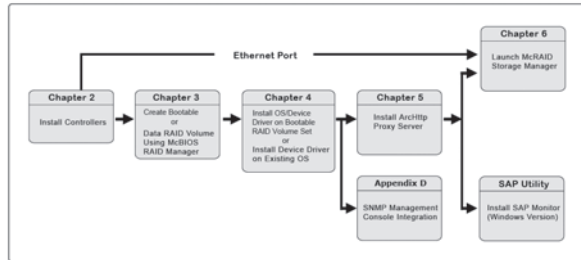

The table below shows the software components that configure and monitor the 12Gb/s SAS RAID controllers.

Configuration Utility	Operating System Supported
McBIOS RAID Manager	OS-Independent
McRAID Storage Manager (Via Ethernet port)	OS-Independent
McRAID Storage Manager (Via ArchHTTP proxy server)	Windows, Linux, FreeBSD, Solaris and Mac OS X
ArchHTTP Proxy Server	Windows, Linux, FreeBSD, Solaris and Mac OS X
CLI Utility	Windows, Linux, FreeBSD, Solaris and Mac OS X
SNMP Manager Console Integration	Windows, Linux, FreeBSD and Solaris
SAP Monitor (Single Admin Portal to scan for multiple RAID units in the network, via ArchHTTP proxy server)	Windows

McRAID Storage Manager

Before launching the firmware-embedded web browser, McRAID storage manager through the PCIe bus, you need first to install the ArchHTTP proxy server on your server system. If you need additional information about installation and start-up of this function, see the McRAID Storage Manager section in Chapter 6 of the user manual.

HARDWARE INSTALLATION

ArcHTTP Proxy Server

ArcHTTP has to be installed for GUI RAID console (MRAID storage manager) to run. It is used to launch the web browser McRAID storage manager. It also runs as a service or daemon in the background that allows capturing of events for mail and SNMP traps notification. If you need additional information about installation and start-up of this function, see the ArcHTTP Proxy Server Installation section in Chapter 5 of the user manual.

CLI Utility

CLI (Command Line Interface) lets you set up and manage RAID controller through a command line interface. CLI performs many tasks at the command line. You can download CLI manual from Areca website or software CD <CDROM>\ DOCS directory.

SNMP Manager Console Integration

There are two ways to transport SNMP data on the 12Gb/s SAS RAID controller: in-band PCIe host bus interface or out-of-band built-in LAN interface. Enter the "SNMP Tarp IP Address" option on the firmware-embedded SNMP configuration function for user to select the SNMP data agent-side communication from the out-of-band built-in LAN interface. To use in-band PCIe host bus interface, keep blank on the "SNMP Tarp IP Address" option.

● Out of Band-Using LAN Port Interface

Out-of-band interface refers to transport SNMP data of 12Gb/s SAS controllers from a remote station connected to the controller through a network cable. Before launching the SNMP manager on the client, you need firstly to enable the firmware-embedded SNMP agent function and no additional agent software inquired on your server system. If you need additional information about installation and start-up this function, see the section 6.8.4 "SNMP Configuration" of the user manual.

● In-Band-Using PCIe Host Bus Interface

In-band interface refers to management of the SNMP data of 12Gb/s SAS controllers from a PCIe host bus. In-band interface is simpler than out-of-band interface for it requires less hard-

HARDWARE INSTALLATION

ware in its configuration. Since the 12 Gb/s SAS RAID controller is already installed in the host system, no extra connection is necessary. Just load the necessary in-band Areca SNMP extension agent for the controllers. Before launching the SNMP agent in the sever, you need first to enable the firmware-embedded SNMP community configuration and install Areca SNMP extension agent in your server system. If you need additional information about installation and start-up the function, see the SNMP Operation & Installation section in the Appendix D of the user manual.

Single Admin Portal (SAP) Monitor

This utility can scan for multiple RAID units on the network and monitor the controller set status. For additional information, see the utility manual (SAP) in the packaged CD or download it from the web site <http://www.areca.com.tw>.