



MARS 400S PRO II

User Manual

V1.0

HOLLYVIEW

Powered by Hollyland

FOREWORD

Thank you for purchasing Hollyland MARS 400S PRO II Wireless HD Video Transmission system. Please kindly read this manual carefully before using it. Hope you have a pleasant experience.

KEY FEATURES

- 450ft Transmission Range between TX and RX(LOS)
- 300ft Transmission Range between TX and APP(LOS)
- Integrated Cold Shoe for Quick Installation
- Latency as low as 56ms
- SDI Input & HDMI Input at TX
- SDI Output & HDMI Output at RX
- This device contains 2 modes:
- HD Mode (12M)
- Focus (56ms)
- Supports DC Power Supply, USB Type-C Power Supply and Battery Power Supply
- 1 Transmitter Supports 2 Receivers(1 Transmitter Supports 1 Receiver and 2 APPs Monitoring, or 1 Transmitter Supports up to 4 APPs Monitoring Without Receiver)
- Supports Smart Channel Selection
- Supports APP Firmware Upgrade
- Direct Data Stream from RX for Live Streaming

Note: The LOS range of up to 450ft (150m) and transmission latency of 56ms provided above are based on laboratory testing results.

PACKING LIST

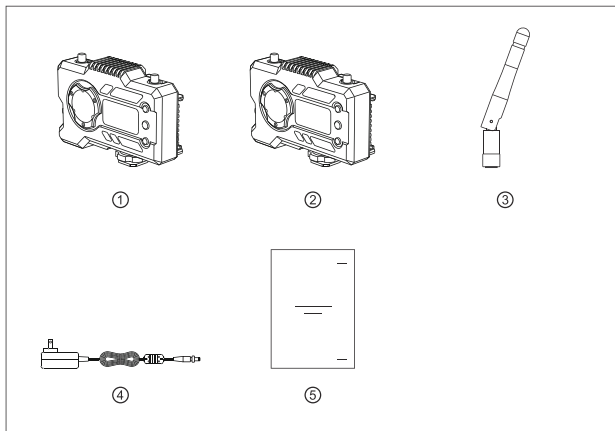

1 TX WITH 1 RX PACKING

① Transmitter	x1
② Receiver	x1
③ Antenna	x5
④ DC Adapter	x1
⑤ User Guide	x1

PACKING LIST

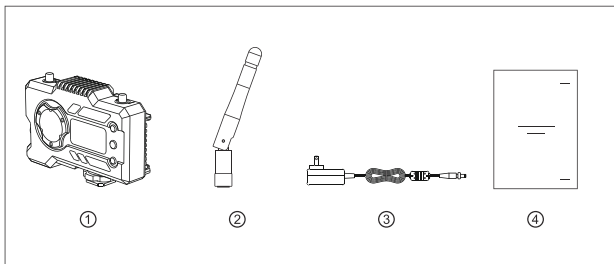

SINGLE RECEIVER PACKING

① Receiver	x1
② Antenna	x3
③ DC Adapter	x1
④ User Guide	x1

TYPICAL SETUP

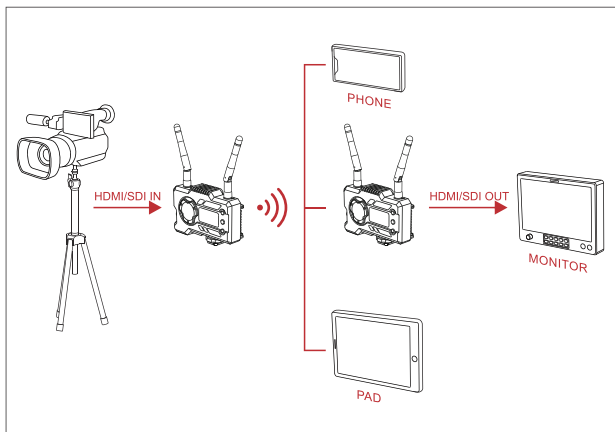

1 TX-1 RX SETUP

TYPICAL SETUP

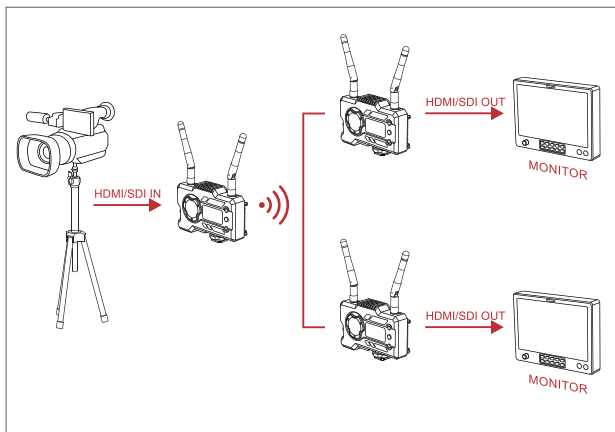

1 TX-2 RX SETUP

PRODUCT INTERFACES

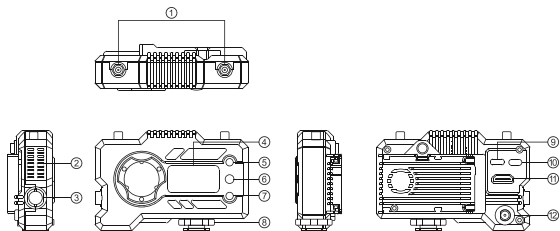

A

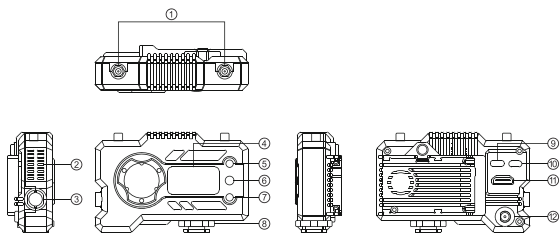

B

A TRANSMITTER

- ① Antenna Interface
- ② Fan Air Outlet
- ③ SDI Input
- ④ OLED Display Screen
- ⑤ UP
- ⑥ OK
- ⑦ DOWN
- ⑧ Cold Shoe
- ⑨ USB Type-C Interface
- ⑩ Power Switch
- ⑪ HDMI Input
- ⑫ DC Input

B RECEIVER

- ① Antenna Interface
- ② Fan Air Outlet
- ③ SDI Output
- ④ OLED Display Screen
- ⑤ UP
- ⑥ OK
- ⑦ DOWN
- ⑧ Cold Shoe
- ⑨ USB Type-C Interface
- ⑩ Power Switch
- ⑪ HDMI Output
- ⑫ DC Input

INSTALLATION

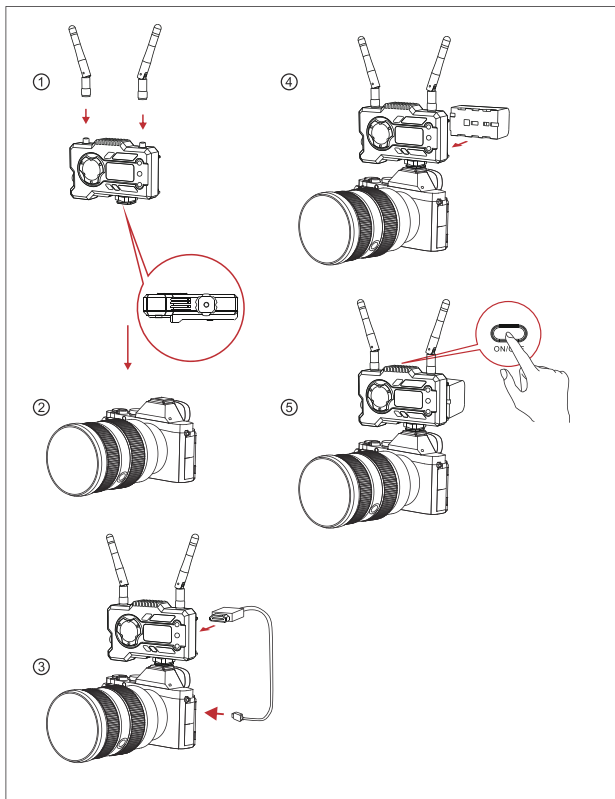

INSTALLATION

- ① Install the antennas as demonstrated.
- ② Secure the cold shoe with 1/4 screw hole at the bottom of the transmitter and mount it to the camera.
- ③ Connect the HDMI input or SDI input of the transmitter with camera's by HDMI or SDI cable.
- ④ Connect to a power supply(compatible with NP-970 battery or the same series of the batteries).
- ⑤ Turn on the devices.

OLED DISPLAY

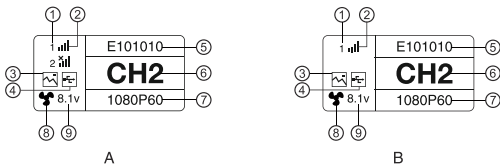

A TRANSMITTER

- ① Device Number
- ② WIFI Signal Strength
- ③ Scene Mode
- ④ USB Flash Detection Indicator
- ⑤ Device ID
- ⑥ Channel Display
- ⑦ Video Format
- ⑧ Fan Status
- ⑨ Battery Voltage Display

B RECEIVER

- ① Device Number
- ② WIFI Signal Strength
- ③ Scene Mode
- ④ USB Flash Detection Indicator
- ⑤ Device ID
- ⑥ Channel Display
- ⑦ Video Format
- ⑧ Fan Status
- ⑨ Battery Voltage Display

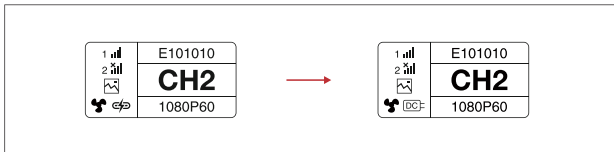

CAUTION

1. This device supports several power methods, and the device will be charged by the method which has a higher voltage.

* The picture on the left shows the symbol of Type-C power supply, the picture on the right shows the symbol of DC power supply.

QUICK GUIDE

ENTER MENU

Long press the “OK” button for 3 seconds to enter the root menu interface. Click “UP” and “DOWN” button to switch menu options, click “OK” to confirm.

CHANNEL CHANGE

Press the button “UP/DOWN” on the transmitter or the receiver to change the current channel. Press “OK” to confirm the channel number, then the channel of the receiver and the transmitter will be synchronously and automatically changed.

PULL STREAM FROM RECEIVER

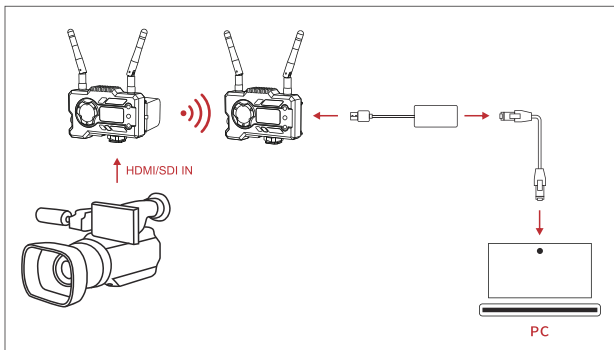

1. Confirm there is video format display on both transmitter and receiver. Use the Type-C to Lan Connector to connect the laptop and RX.
2. Go to the network settings on the laptop and set it to DHCP mode.
3. Go to your live stream software, such as VLC Player, OBS Studio, Vmix, etc., and open the network video source via the RTSP URL: `rtsp://192.168.218.25:5554`.

APP DOWNLOAD AND CONNECTION

1. "HollyView" APP Download



2. Connecting Method:

Enter the WiFi connection interface of mobile phone and find out the WiFi named as "HLD + DEVICE ID", and input the WiFi password to connect (Factory Default Password is: 12345678). After successful connection, you can have the APP monitoring.

PRODUCT PARAMETERS

	Transmitter	Receiver
Interfaces	HDMI Input(Type A Female) SDI Input 2* Antenna Interfaces (RP-SMA Male) DC Input USB Type-C	HDMI Output(Type A Female) SDI Output 2* Antenna Interfaces (RP-SMA Male) DC Input USB Type-C
Supply Interfaces	DC Power Input:6-16V USB Type-C Power Supply:5V/2A Battery Power Supply:6-16V DC	DC Power Input:6-16V USB Type-C Power Supply:5V/2A Battery Power Supply:6-16V DC
Power Consumption	<11W	<7W
Weight	206g	206g
Dimension	(L*W*H): 110*72*33.5mm (The Battery Plate Exclude)	(L*W*H): 110*72*33.5mm (The Battery Plate Exclude)
Input / Output Video Format	HDMI: 720p50/59.94/60 1080i50/59.94/60 1080p23.98/24/25/29.97/30 1080p50/59.94/60 SDI: 1080p60/59.94/50(Level A) 1080p60/59.94/50(Level B) 1080i60/59.94/50 1080p30/29.97/25/24/23.98 1080psf24/23.98 1080psf30/29.97/25 720p60/59.94/50	HDMI: 720p50/60 1080i50/60 1080p24/25/30 1080p50/60 SDI: 1080p60/50(Level A) 1080i60/50 1080p30/25/24 1080psf24 720p60/50
Frequency	5GHz	5GHz
Transmission Power	≤21+/-1.5dBm	/
Receiver Sensitive	/	-80dBm
Transmission Latency*	HD Mode: 66ms Focus : 56ms	HD Mode: 66ms Focus : 56ms
Bandwidth	20MHz /	20MHz

Note: The operating frequency and TX power vary by country and region. In some countries and regions, the 5.1GHz, 5.2GHz, and 5.8GHz frequency bands are prohibited, or the 5.1GHz and 5.2GHz frequency bands are only allowed for indoor use. Please refer to local laws and regulations for more information.

* test data when 1080p60 signals are transmitted in a laboratory environment.

If encounter any problems in using the product or need any help, please follow these ways to get more technical support:

 Hollyland Products User Group

 HollylandTech

 HollylandTech

 support@hollyland.com

 www.hollyland.com

