

## VenusLiv User Manual

V2.0.0

## Packing List

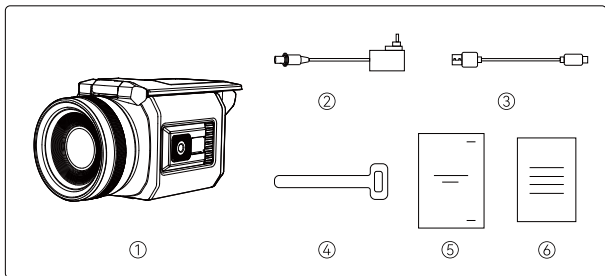

① VenusLiv	x1
② 12V 2A Adapter	x1
③ USB Cable	x1
④ Cable Tie	x1
⑤ User Manual	x1
⑥ Warranty Card	x1

## Parts Description

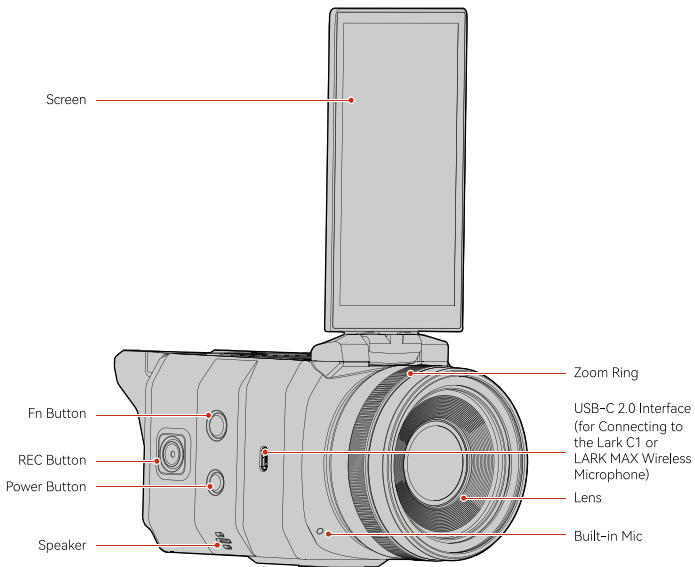

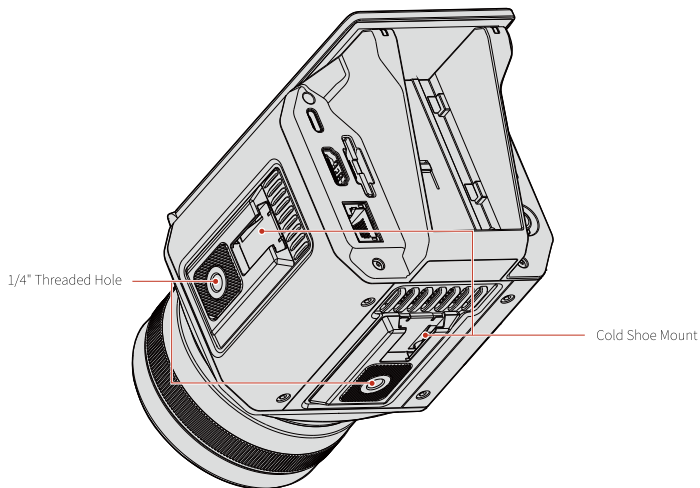
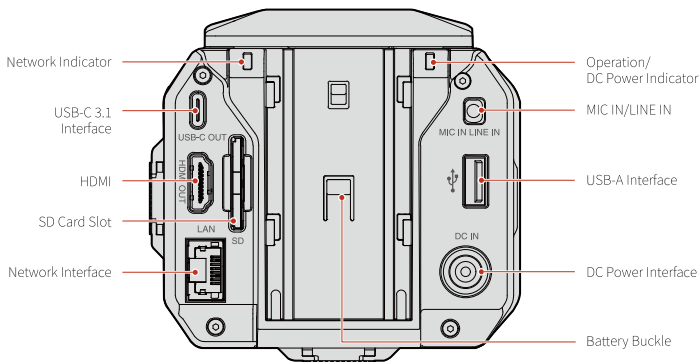

## Parts Functions

### Power Button

Press and hold the button for 3 seconds to turn on or off the camera.

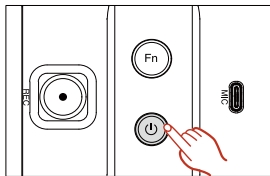

### Fn Button

Press the button to switch between the live scenes.

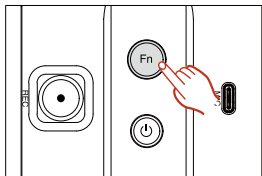

### REC Button

- Live mode: Press the button to start live broadcasting.

#### Note:

A network connection and streaming URL are required to start live broadcasting.

- Photo mode: Press the button to take photos.

#### Note:

A storage device is required to take photos.

- Video mode: Press the button to take videos.

#### Note:

A storage device is required to take videos.

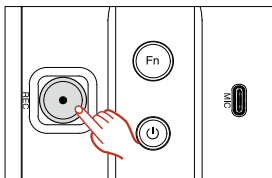

### USB-C 2.0 Interface for Connecting to the Lark C1 or LARK MAX Wireless Microphone

The interface supports connecting to the Lark C1 or LARK MAX wireless microphone. Compatibility issues may be caused when audio devices with other USB-C interfaces are connected.

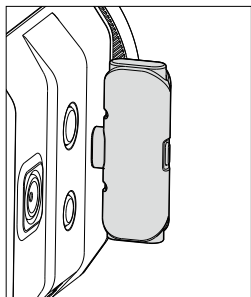

## USB-C 3.1 Interface for Performing UVC Streaming

The interface supports connecting to a PC via a USB cable to transmit audio & video streams.

### Note:

Please use the original USB-C 3.0 cable. Cables lower than USB-C 3.0 may not support the transmission of your audio & video streams.

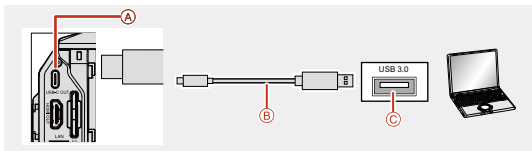

## HDMI

### HDMI Same-Screen Output:

When the camera is connected to a monitor, the camera UI can be synchronously displayed on the monitor for monitoring.

### HDMI Content-Only Output:

When the camera is connected to a broadcasting station or monitor, audio & video streams can be output for streaming.

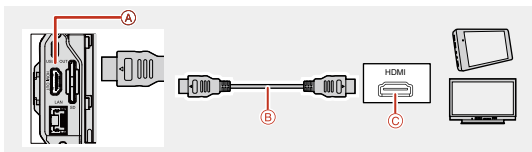

## RJ45 Interface

The interface is used for connecting to the network and performing streaming.

Green light: The camera is properly connected to the network.

Red light: The camera is not connected to the network.

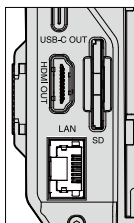

## 3.5mm Interface

The interface is used for connecting to a three-section LINE IN or MIC IN device.

### Note:

When a LINE IN or MIC IN device is connected, please select the corresponding mode. Otherwise, abnormal audio reception or even no audio reception may be caused.

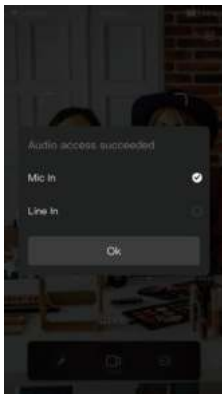
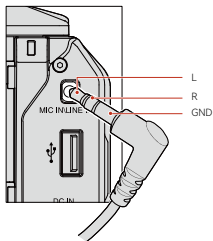

## USB-A Interface

The interface is used for connecting to a USB flash drive to store photos or videos or connecting to a mouse or keyboard to operate the camera.

### Note:

1. Do not unplug the USB flash drive when the camera is transmitting or accessing information. Otherwise, data may be lost or damaged, or even the USB flash drive or camera may be damaged. Before replacing or unplugging the USB flash drive, please turn off the camera. The losses caused by the use of a damaged USB flash drive, including data loss, cannot be recovered.
2. When shooting videos, please use a class 10 USB flash drive or above to store videos. The maximum size of a video file is 4GB.

3. If you are prompted that you do not have full permission to use the USB flash drive to store data, please check or replace the USB flash drive.



## SD Card Slot

- **Inserting the SD card**

Insert the SD card until it clicks into place. Please insert the SD card correctly to avoid a malfunction.

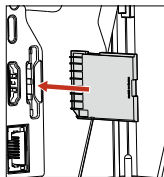

- **Removing the SD card**

Push in the SD card lightly once to remove it.

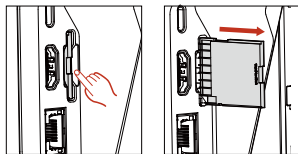

## DC Power Interface

Power adapter interface. It is strongly recommended to use the original adapter to avoid the risk of camera damage.

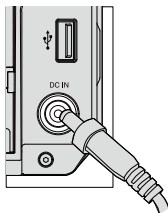



## Note:

1. Do not remove the SD card when the camera is transmitting or accessing information. Otherwise, data may be lost or damaged, or even the SD card or camera may be damaged. Before replacing or removing the SD card, please turn off the camera. The losses caused by the use of a damaged SD card, including data loss, cannot be recovered.
2. When shooting videos, please use a class 10 SD card or above to store videos. The maximum size of a video file is 4GB.
3. If you are prompted that you do not have full permission to use the SD card to store data, please check or replace the SD card.

## Battery Slot

### • Installing the battery

Align the battery contact point with the battery connection seat in the battery slot and insert the battery into the battery slot.

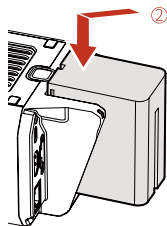
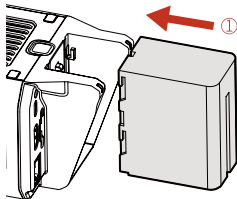

### • Removing the battery

- ① Press and hold the battery release button.
- ② Push up the battery to remove it.

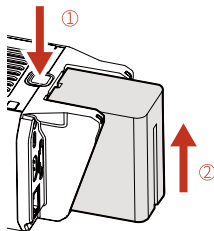

## 1/4" Threaded Hole

Used for installing the camera horizontally or vertically.

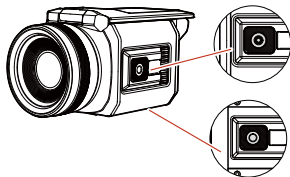

## Cold Shoe Mount

Used for mounting external devices.

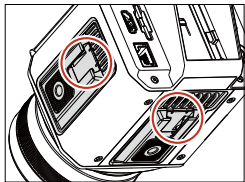

## Zoom Ring

- Rotate the zoom ring clockwise to reduce the focal distance.
- Rotate the zoom ring counterclockwise to increase the focal distance.

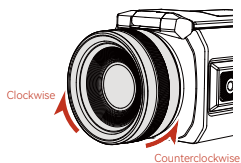

## Screen

- **Up**  
The screen can only open to 180°. Be careful not to open the screen any further than this.
- **Left**  
The screen can only open to 180°. Be careful not to open the screen any further than this.
- **Right**  
The screen can only open to 130°. Be careful not to open the screen any further than this.

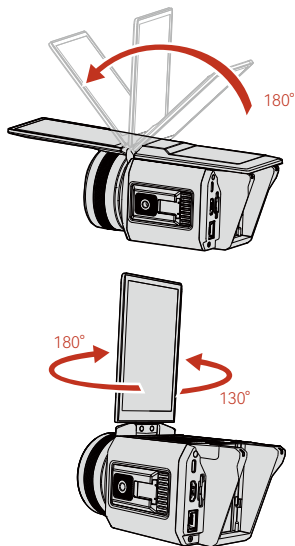

## UVC Streaming

1. Connect the camera to a computer via a USB cable. (Note: The USB interface on the computer and the USB cable are required to support the USB-C 3.0 standard.)
2. Open streaming software or live broadcasting software on the computer.
3. Select devices.
  - Select **HOLLYLAND FHD Camera** as the camera.
  - Select **HOLLYLAND** as the audio device.

## Streaming to a Broadcasting Station via an HDMI Cable

1. Connect the camera to a broadcasting station via an HDMI cable. (Note: The HDMI cable is required to support HDMI 1.4 or above.)
2. Select **HDMI Content-Only Output** in the dialog box that is displayed. (Note: **HDMI Same-Screen Output** is not recommended for streaming.)
3. Enter the corresponding streaming URL after the camera video streams and sound are displayed on the broadcasting station. (Note: The broadcasting station needs to be connected to the network.)
4. Tap **Live** on the broadcasting station to start streaming.

## Connecting to a Monitor via an HDMI Cable

1. Connect the camera to a monitor via an HDMI cable. (Note: The HDMI cable is required to support HDMI 1.4 or above.)
2. Select **HDMI Same-Screen Output** or **HDMI Content-Only Output** in the dialog box that is displayed.
3. The connection is successful after the camera video streams and sound are displayed on the monitor.

# Home Screen

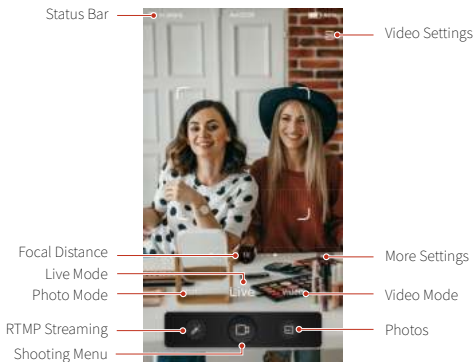















## Navigation





1. Swipe down from the top to enter the quick settings interface.
2. Swipe up from the bottom to enter the main interface.
3. Swipe left or right to return to the previous interface.

## Status Icon Description

	The camera is using an Ethernet network.
	The camera is using a Wi-Fi network.
	No network currently.
Am10:00	Current time.
	The audio device connected to the camera is the Lark C1 or LARK MAX wireless microphone.
	The audio device connected to the camera is a MIC IN device.
	The audio device connected to the camera is a LINE IN device.
	An SD card has been inserted into the camera.
	A USB device has been inserted into the camera.
	UVC streaming is in progress.
	Only USB-C connection currently.
	The camera is connected to a device via an HDMI cable.
	Camera Bluetooth is enabled.
	The camera is powered by a power source other than a battery.
	The camera is powered by a battery.

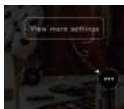
## More Settings



Tap  to view more functions and parameters, including screen rotation, live scenes, and Pro parameters.

## Streaming URL

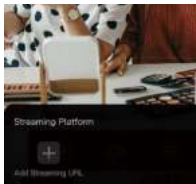

There are two ways to add a streaming URL.

Method 1: Scan the QR code on a mobile phone, enter the streaming name and streaming URL, and tap **Submit**. The information will be synchronized to the camera. Then tap **Finish** on the camera.



Method 2: Tap **Manually Add Streaming URL**, enter the streaming name and streaming URL, and then tap **Finish**.

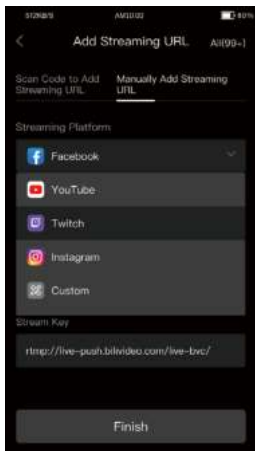

## Streaming URL

The streaming server address and stream key are required for entering the streaming URL.

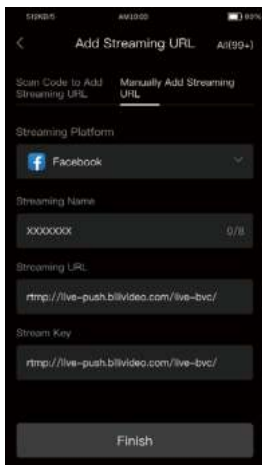

The screenshot shows a mobile application interface for adding a streaming URL. At the top, there is a navigation bar with a back arrow, the title "Add Streaming URL", and an "Add(99+)" button. Below the navigation bar, there are two tabs: "Scan Code to Add Streaming URL" and "Manually Add Streaming URL", with the latter being selected. The main content area is divided into several sections:

- Streaming Platform:** A dropdown menu currently set to "Facebook".
- Streaming Name:** A text input field containing "XXXXXXXX" with a character count of "0/8".
- Streaming URL:** A text input field containing the URL "rtmp://live-push.blivideo.com/live-bvc/".
- Stream Key:** A text input field containing the stream key "rtmp://live-push.blivideo.com/live-bvc/".

At the bottom of the screen, there is a large, light-colored button labeled "Finish".

## Live Scene

The camera supports multiple live scenes.



## Pro Parameters



EV	Adjust the exposure compensation.
ISO	Adjust the camera sensitivity.
WB	Adjust the white balance.
Shutter	Adjust the shutter speed.
Aperture	Adjust the camera aperture.

## Pro Parameter Settings

### EV

Range: -3 to 3

**Adjust the exposure compensation:**

Tap EV and tap or slide the EV adjustment area.

### Note:

When either the ISO or the shutter is in the AUTO mode, the EV can be adjusted. When neither the ISO nor the shutter is in the AUTO mode, the EV cannot be adjusted.



### ISO

Range: 100 to 6400

**Adjust the camera sensitivity:**

Automatic (A): The camera automatically adjusts the sensitivity according to the environment.

Manual: Tap ISO and tap or slide the ISO adjustment area.





## WB

Range: 3000 to 7000

**Adjust the white balance:**

Automatic (A): The camera automatically adjusts the white balance according to the environment.

Manual: Adjust the white balance according to the actual live broadcasting environment.



## Shutter

**Adjust the shutter speed:**

Tap **Shutter** and select a shutter speed.



## Aperture

Range: F1.2, F1.6, F2.0

**Adjust the aperture:**

Tap **Aperture** and select an aperture value.





## Video Settings

**Enter the video settings:**

In the live mode or video mode, tap  in the upper right corner.

## Resolution

**Adjust the video resolution:**

Go to  >  and select a desired resolution. A higher resolution in the live mode requires a larger bandwidth, and a higher resolution in the video mode generates a larger video file.



## Bit Rate

Adjust the bit rate:

Go to  >  and select a desired bit rate.

## Video Saving Interval

Adjust the video saving interval:

Go to  >  and select a desired video saving interval. The settings take effect only in the video mode.

## Zoom Range

Range: 1x to 6x

Adjust the zoom range:

Method 1: Select a zoom value.



Method 2: Pinch to zoom in or out.

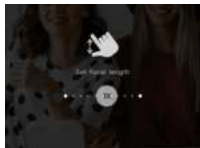

Method 3: Rotate the zoom ring to adjust the focal distance.

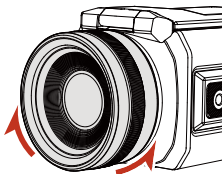

### Note:

The focal distance in the live, photo, and video modes is the same.

## Anti Banding

Select a proper frequency option to avoid camera flickering in the light.

# Camera Modes

## Photo Mode

Tap the shooting menu to take photos.

## Video Mode

Tap the shooting menu to take videos.

### **Note:**

Because photos and videos can only be stored on external devices, an SD card or USB flash drive is required when you are taking photos or videos. You can view the corresponding files in the photos or files.

## RTMP Live Mode

Tap the shooting menu to start live broadcasting.

### **Note:**

The prerequisites for starting live broadcasting are as follows:

1. The camera has been connected to an Ethernet or Wi-Fi network.
2. A streaming URL has been added.

# Quick Settings

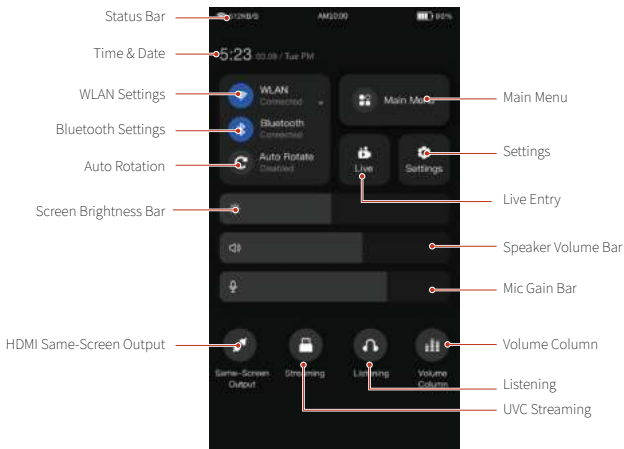

## WLAN Settings

Tap the icon to turn the WLAN function on or off, or tap and hold the icon to enter the WLAN interface.

## Bluetooth Settings

Tap the icon to turn the Bluetooth function on or off, or tap and hold the icon to enter the Bluetooth interface.

## Auto Rotation

Tap the icon to turn the auto rotation function on or off.

## Screen Brightness Bar

Move the slider to adjust the screen brightness.

## Speaker Volume Bar

Move the slider to adjust the speaker volume.

## Mic Gain Bar

Move the slider to adjust the mic gain.

## HDMI Same-Screen Output

After the camera is connected to a device via an HDMI cable, swipe down to enter the quick settings interface and tap the **Same-Screen Output** icon. You can switch between **HDMI Same-Screen Output** and **HDMI Content-Only Output**.

## Settings

Swipe down to enter the quick settings interface and tap the **Settings** icon to enter the camera settings interface.

## Live Entry

Swipe down to enter the quick settings interface and tap the **Live** icon to enter the live interface.

## UVC Streaming

After the camera is connected to a device via a USB-C 3.0 cable, swipe down to enter the quick settings interface and tap the **Streaming** icon to enter the UVC streaming mode.



## Main Menu

Swipe down to enter the quick settings interface and tap the **Main Menu** icon to enter the main menu interface. Tap an app on the main menu interface to enter the app.

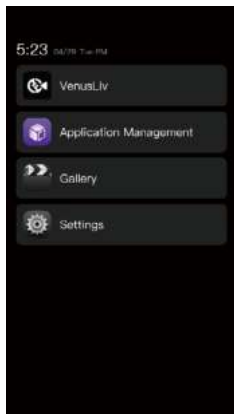

## Volume Column

Swipe down to enter the quick settings interface and tap the **Volume Column** icon to turn the function on or off. You can monitor the audio gain in the live mode or video mode.

## Listening

Swipe down to enter the quick settings interface and tap the **Listening** icon to enter the listening mode.

## Connecting to a WLAN

1. Go to **Settings > WLAN** and turn on the WLAN function.
2. On the WLAN settings interface, choose the WLAN to be connected from the available WLAN list. If an encrypted network is selected, a password is required.

## Deleting a WLAN

1. Go to **Settings > WLAN** and turn on the WLAN function.
2. Tap and hold the WLAN to be deleted in the connected WLAN list and tap **Delete**.

## Wired Network

Go to **Settings > Wired Network** and turn on or off the wired network function.

The wired network function is turned on by default. When a network cable is inserted into the camera, the camera automatically connects to the network.

## Entering an IP Address Manually

Go to **Settings > Wired Network**, turn off the **Obtain IP Address Automatically** function, enter a desired IP address, subnet mask, and default gateway, and tap **Save**. If the **Obtain IP Address Automatically** function is turned on, the IP address, subnet mask, and default gateway will be obtained automatically by default.

## Entering a DNS Server Address Manually

Go to **Settings > Wired Network**, turn off the **Obtain DNS Server Address Automatically** function, enter a desired preferred DNS server address and alternate DNS server address, and tap **Save**. If the **Obtain DNS Server Address Automatically** function is turned on, the preferred DNS server address and alternate DNS server address will be obtained automatically by default.

## Bluetooth

Go to **Settings > Bluetooth** and turn on or off the Bluetooth function.

## Changing the device Bluetooth name:

1. Go to **Settings > Bluetooth** and turn on the Bluetooth function.
2. Tap the device Bluetooth name, enter a new name, and tap **OK**.

## Connecting to a Bluetooth device:

1. Turn on a Bluetooth device and make sure it is discoverable.
2. Go to **Settings > Bluetooth** and turn on the Bluetooth function. Then, the camera automatically searches for available Bluetooth devices.
3. Choose the device to be connected in the available Bluetooth device list and complete pairing as prompted.

Disconnecting from a Bluetooth device:

1. Go to **Settings > Bluetooth** and turn on the Bluetooth function.
2. Tap and hold the Bluetooth device to be disconnected in the connected Bluetooth device list and tap **Delete**.

### App Management

- **Opening an app**  
Go to **Settings > App Management** and tap the app to be opened.
- **Updating an app**  
Go to **Settings > App Management** and tap the app to be updated.

### Volume & Brightness Adjustment

Go to **Settings > Sound & Brightness** to adjust the screen brightness and volume.

- **Adjusting the screen brightness**  
Move the slider on the screen brightness bar to adjust the screen brightness.
- **Adjusting the volume**  
Move the slider on the speaker volume bar to adjust the speaker volume.  
Move the slider on the mic gain bar to adjust the mic gain.

### Storage

- **Clearing camera cache**  
Go to **Settings > Storage** and tap **Clear** to clear the camera cache.
- **Deleting app data**  
Go to **Settings > Storage**, tap an app to enter the app management interface, and tap **Delete Data**.
- **Clearing app cache**  
Go to **Settings > Storage**, tap an app to enter the app management interface, and tap **Clear Cache**.
- **Memory**  
Installed systems and software occupy some memory.

### File Management

You can view photos and videos on the storage devices.

# System & Update

## System Upgrade

When a new version is released, the camera will prompt you to download and install the latest firmware to upgrade the system.

### Note:

Keep the power adapter connected to the camera and do not cut off the power during the upgrade. If the upgrade fails and the camera cannot be used, please contact our after-sales personnel.

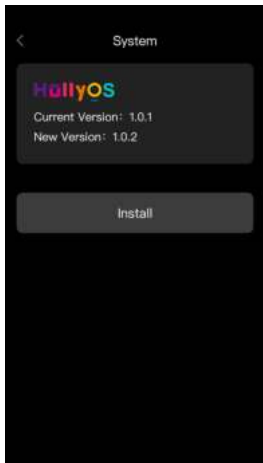

## Language

Go to **Settings > System & Update > Language** and select a desired language.

## Restoring Default Settings

Go to **Settings > System & Update > Restore**, tap **Reset Camera**, and reset the camera as prompted.

### Note:

This operation will delete data from the internal storage of the camera (including account information, system & app data, and system settings). Please back up the data before performing this operation to avoid data loss.

## About Camera

You can view the basic information and legal information of the camera.



## Photo Interface

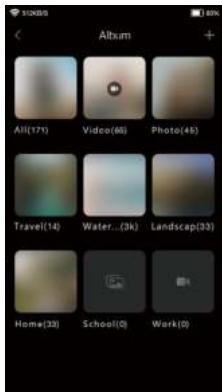

## File Details

You can tap a photo or video and view it in full screen. You can also tap the screen again to hide the menu.

When you are viewing a photo or video in full screen, you can tap  to view parameter information such as the storage path, resolution, and size of the photo or video in the popup menu that is displayed.

## Moving Photos & Videos

1. Tap the photo or video to be moved.
2. Tap **Move** and select an album or create an album to which the photo or video is to be moved.
3. After the file is moved, it will no longer be stored in the original album.

## Renaming Photos & Videos

1. Tap the photo or video to be renamed.
2. Tap **Rename** and enter a new name.
3. Tap **OK**.

## Deleting Photos & Videos

Tap the photo or video to be deleted (tap and hold the file to select multiple files), tap **Delete**, and then tap **OK**.

### Note:

Deleted photos or videos cannot be restored.

## Creating an Album

1. Go to photos and enter the album interface.
2. Tap **+**, enter a new album name, and tap **OK**.
3. Select the photo or video to be added to the new album and then move it to the album.

## Sorting Photos & Videos

Go to photos, enter the album interface, and tap  in the upper right corner to start sorting. Sorting by creation time, file name, or file size in ascending or descending order is supported.

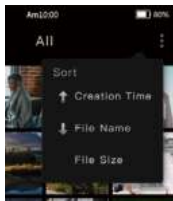

## Status Indicators

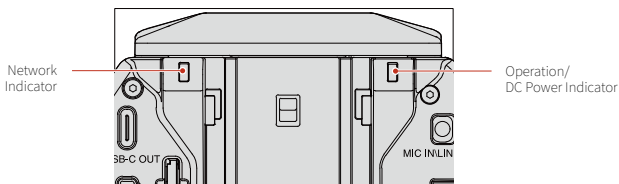

### Network indicator light: Red/Green ■ ■

- Steady green light: Successful network connection
- Steady red light: Abnormal network connection
- Light OFF: Camera being initialized

### Operation indicator light: Red/Green ■ ■

- Steady green light: Normal operation
- Green light flashing slowly: Camera being initialized
- Steady red light: Abnormal camera status  
Example: Abnormal or full file storage, low battery, etc.
- Red light flashing slowly: Firmware upgrade in progress

### DC power indicator: Yellow ■

- Yellow light ON: The camera is connected to a DC power adapter.
- Yellow light OFF: The camera is battery-powered/The camera is turned on.

## Specifications

CPU	Qualcomm	
CMOS	Sony	
OS	HollyOS	
Weight	900g (31.7oz)	
Dimensions	(LxWxH): 178mmx99.7mmx94.8mm (7"x3.9"x3.7")	
Power Consumption	<12W	
Input Voltage	12V DC	
Wireless Technology	Wi-Fi: 2.4 GHz + 5 GHz	Bluetooth 5.0
Operating Temperature	-10° C to 40° C	
FOV	80° (Horizontal) / 46° (Vertical)	
Zoom	6x zoom is supported.	
Focus	Auto hybrid focus	
Touch Screen	5" LCD	1080x1920px
External Battery	NP-F batteries	
Interface	DC IN	DC interface with a threaded lock
	MIC IN/LINE IN	3.5mm
	HDMI OUT	Type A@HDMI 1.4
	SD card slot	SDIO3.0 @SDXC
	USB-C OUT	USB-C 3.1
	MIC	USB-C 2.0 for connecting to the Lark C1 or LARK MAX wireless microphone.
	USB-A	USB 2.0
	RJ45	1.0 Gbps

### Warning:

If you fail to take the following precautions, you may be seriously injured or killed by the electric shock or fire disaster caused, or your VenusLiv may be damaged. Please check whether the camera and accessories are intact before using them. For security reasons, only Hollyland accessories that are provided with the camera or genuine ones purchased can be used. The use of any other parts, accessories, or chargers not recommended by Hollyland may cause fire disaster, electric shock, or personal injury. Damage caused by the use of unauthorized accessories is not covered by the warranty. For approved accessories, please visit the Hollyland official website at <https://www.hollyland.com>.

Do not touch the plug or adapter with wet hands when connecting the camera to the adapter. Failure to follow this precaution may cause electric shock.

1. Do not place or fix the camera on an unstable surface. Failure to follow this precaution may cause the camera loosen or fall off, causing an accident or damage to the camera.
2. When using external power supply connection, please follow all the security rules of the third-party power supply device.
3. The lens of the VenusLiv is made of glass. If the lens is damaged, please handle it carefully to avoid being scratched by the broken lens/glass and keep it away from children.
4. The temperature of the camera may rise during operation. If this occurs, turn off the camera and leave it to cool before using it again.
5. This product is not a toy and you are solely responsible for complying with all local laws, regulations, and restrictions.
6. Do not use the VenusLiv for unauthorized monitoring, candid shooting, or in any way that violates personal privacy regulations. Normally, it is strictly forbidden to use the camera for such purposes. If you fail to follow this precaution, you may bear huge responsibilities and face criminal proceedings.
7. Do not put the camera in extremely cold or hot environments.
8. Extremely cold or hot environments may cause the camera to temporarily stop working properly.

### Note:

There is no protection for the lens of the VenusLiv. If you do not pay attention to it, it is easy to cause scratches. Please store the VenusLiv in the provided box and avoid placing the lens on any surface. Lens scratches are not covered by the warranty.

## Disclaimer

1. Please read and follow all the instructions carefully.
2. Please note all the warnings.
3. Do not use the product near heat sources such as radiators, electric heaters, stoves, or other heat-producing equipment.
4. Use only parts and accessories specified or provided by Hollyland.
5. Please hand over all maintenance work to qualified personnel. No matter what kind of damage the product suffers, such as damage to the power cable or plug, liquid penetration, objects falling into the product, rain, dampness, failure to work normally, or fall, maintenance is required.

## Support

If you encounter any problems in using the product or need any help, please contact Hollyland Support Team via the following ways:

 Hollyland User Group

 HollylandTech

 HollylandTech

 HollylandTech

 support@hollyland.com

 www.hollyland.com

### Statement

All copyrights belong to Shenzhen Hollyland Technology Co., Ltd. Without the written approval of Shenzhen Hollyland Technology Co., Ltd., no organization or individual may copy or reproduce part or all of any written or illustrative content and disseminate it in any form.

### Trademark Statement

All the trademarks are owned by Shenzhen Hollyland Technology Co., Ltd.

### Note:

Due to product version upgrades or other reasons, this User Manual will be updated from time to time. Unless otherwise agreed, this document is provided as a guide for use only. All representations, information, and recommendations in this document do not constitute warranties of any kind, express, or implied.

## FCC Requirement

Any changes or modifications not expressly approved by the party responsible for compliance could void the user's authority to operate the equipment. This device complies with Part 15 of the FCC Rules. Operation is subject to the following two conditions: (1) this device may not cause harmful interference, and (2) this device must accept any interference received, including interference that may cause undesired operation.

### **FCC Radiation Exposure Statement:**

The device has been tested and found to comply with FCC SAR limits.

### **Note:**

This equipment has been tested and found to comply with the limits for a Class B digital device, pursuant to Part 15 of the FCC Rules. These limits are designed to provide reasonable protection against harmful interference in a residential installation. This equipment generates, uses, and can radiate radio frequency energy and, if not installed and used in accordance with the instructions, may cause harmful interference to radio communications. However, there is no guarantee that interference will not occur in a particular installation. If this equipment does cause harmful interference to radio or television reception, which can be determined by turning the equipment off and on, the user is encouraged to try to correct the interference by one or more of the following measures:

- Reorient or relocate the receiving antenna.
- Increase the separation between the equipment and receiver.
- Connect the equipment into an outlet on a circuit different from that to which the receiver is connected.
- Consult the dealer or an experienced radio/TV technician for help.

